

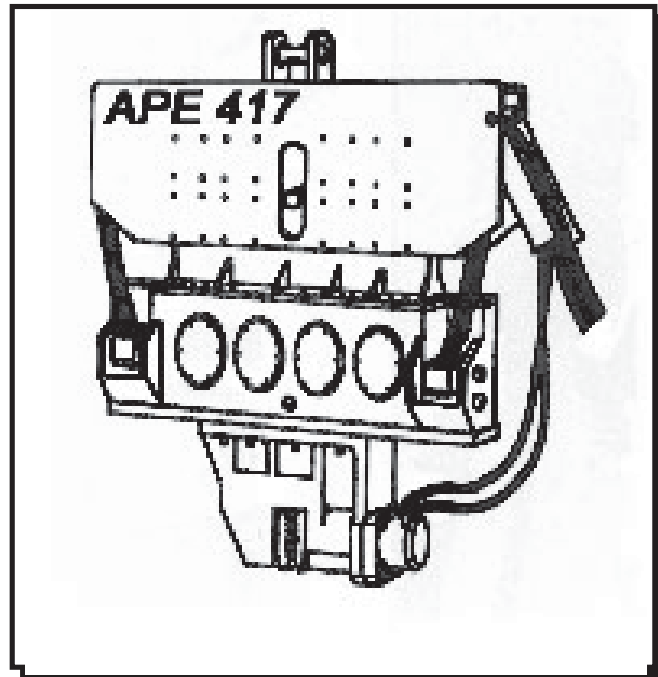

OPERATION AND MAINTENANCE MANUAL



SERIAL NUMBER:

**MODEL 417 VIBRO WITH
MODEL 240 & 260 POWER UNIT**



OPERATION / MAINTENANCE MANUAL

MODEL 417B VIBRATORY HAMMER WITH MODEL 260 POWER UNIT

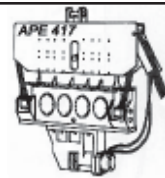

7032 SOUTH 196th - KENT, WA 98032 - (253) 872-0141 / FAX (253) 872-8710

Revision Record

Change Number	Page Number	Date	Revision Description
01	1-2	11/18	Updated weight for 260 power unit



OPERATION / MAINTENANCE MANUAL

MODEL 417 VIBRATORY HAMMER WITH MODEL 260 POWER UNIT

7032 SOUTH 196th - KENT, WA 98032 - (253) 872-0141 / FAX (253) 872-8710

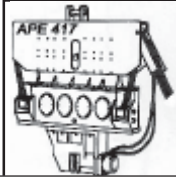

Preface

General

This manual covers the **Model 417 Vibratory Hammer and the Model 240 Power Unit**. The data provided in this manual gives the necessary information to operate and maintain APE equipment. The listed procedures are to be performed by qualified personnel who have an understanding of the equipment and who follow all safety precautions.

Guide to Using the Manual

1. Refer to the Table of Contents for the page location of applicable sections.
2. All weights and measurements in this manual are in both English and Metric units.
3. The manual will be revised as necessary to reflect current information.

Abbreviations

The following are abbreviations used within this manual.

lbs. = Pounds

psi. = Pounds per Square Inch

hp. = Horse Power

gpm. = Gallons Per Minute

rpm. = Revolutions Per Minute

hyd. = Hydraulic

NPT. = National Pipe Thread



OPERATION / MAINTENANCE MANUAL

MODEL 417B VIBRATORY HAMMER WITH MODEL 260 POWER UNIT

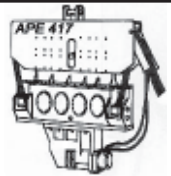

7032 SOUTH 196th - KENT, WA 98032 - (253) 872-0141 / FAX (253) 872-8710

Table of Contents

	Page
Revision Record	i
Preface	ii
Table of Contents	iii
Safety Precautions	v
Illustration List	vi
Table List	vi
Warranty	vii
I. GENERAL INFORMATION	1-1
I-1. Machine Features	1-1
I-2. Machine Specifications	1-2
A. Model 417 Vibro	1-2
B. Model 240 Power Unit	1-2
I-3. General Description of 100 Vibro	1-3
A. Suppressor Housing	1-4
B. The Vibrator Gearbox	1-5
C. Clamp Attachment	1-6
D. Optional Attachments	1-7
I-4. General Description of Model 240 Power Unit	1-8
II. MAJOR COMPONENT DEFINITION	2-1
II-1. Component Identification	2-1
II-2. Vibro Manifold Identification	2-4
II-3. Hose Identification	2-5
II-4. Model 240 Power Unit Skid Identification	2-6
II-5. Quick Disconnect Couplings	2-7
II-6. Tool Set Identification	2-8
II-7. Caisson Clamp Identification	2-9
II-8. Engine Component Identification	2-10
II-9. Major Hydraulic Component Identification	2-13
II-10. Control Panel and Parts	2-21
III. LOADING AND UNLOADING	3-1
III-1. Model 417 Vibratory Hammer	3-1
III-2. Model 240 Power Unit	3-1
III-3. What to do if damaged during shipment	3-1
IV. PREPARATION AND OPERATION	4-1
IV-1. Rigging of Vibratory Hammer	4-1
IV-2. Installing the Clamp Attachment	4-1
IV-3. Plumbing the Vibro Hoses to the Power Unit	4-2
IV-4. Filling Vibrator Pressure Hoses	4-3
IV-5. Bleeding Clamp Attachment Hydraulic Hoses	4-3
IV-6. Precautions and Rules for Operation	4-4
IV-7. Relief Valve Settings Prior to Operation - Model 240	4-5
IV-8. Shut-down Procedures	4-5
IV-9. Operation of the Remote Control Pendant	4-6
IV-10. Normal Steps to Operate Vibrator	4-6
V. MAINTENANCE	5-1
V-1. Daily Maintenance Required Prior to Operation	5-1
V-2. Checklist After Power Unit Engine Has Started	5-1
V-3. Maintenance and Adjustments: (75Hours)	5-2
V-4. Maintenance and Adjustments: (Eccentric Bearings)	5-2
V-5. Maintenance and Adjustments in Severe Conditions	5-2
V-6. Lubrication	5-2
A. Vibratory Gearbox	5-2
B. Clamp Attachment	5-2
V-7. Power Unit	5-3
V-8. Hydraulic Motor - Installation and Start-Up	5-6
VI. TROUBLESHOOTING: Model 417 Vibro	6-1



OPERATION / MAINTENANCE MANUAL

MODEL 417 VIBRATORY HAMMER WITH MODEL 260 POWER UNIT

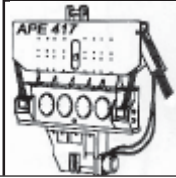

7032 SOUTH 196th - KENT, WA 98032 - (253) 872-0141 / FAX (253) 872-8710

Table of Contents (Continued...)

VII. MODEL 240 POWER UNIT	7-1
VII-1. Hydraulic Circuitry	7-1
A. Clamp Circuit	7-1
B. Drive Circuit	7-1
C. Return Filter	7-2
D. Heat Exchanger	7-2
E. Manual Pump	7-2
F. Hydraulic Oil Temperature	7-2
G. Hydraulic Components	7-2
H. Hydraulic Schematic	7-3
VII-2. Electrical Controls (Understanding How They Work)	7-4
A. Main Circuit Breaker	7-4
B. Tachometer	7-4
C. Hourmeter	7-4
D. Engine Safety Shut-Down Switch	7-4
E. Murphy "Engine Oil Pressure" Gage	7-4
F. Murphy "Engine Oil Temp" Gage	7-4
G. Murphy "Hyd. Oil Temp." Gage	7-4
H. Hyd. Oil Level Float Switch	7-4
I. Pendant "Emergency Stop" Button	7-4
J. Radio "Emergency Stop" Button	7-4
K. Pilot Lights	7-4
L. Engine Control Switch "OFF-ON-START"	7-5
M. "Local Pendant" Switch	7-5
N. Governor Control Switches "RAISE-OFF-LOWER"	7-5
O. Clamp Control Switches "OPEN-OFF-CLOSE"	7-5
P. Drive Control Switches	7-7
Q. Preparing the Electrical System for Engine Startup	7-7
R. Electrical Schematic for "Pendant Control"	7-8
 VIII. POWER UNIT UPGRADES	 7-15
VIII-1. Upgrading to Murphy Gages	7-15
VIII-2. Upgrading Governor Control Wiring	7-16
VIII-3. Upgrading the Drive and Clamp Switches	7-16

APPENDIX A - CUMMINS 6CTA8.3 ENGINE

A-1. ENGINE OPERATION INSTRUCTIONS	A-1
A. Pre-Start Inspection and Procedures	A-1
B. Starting The Engine	A-2
C. Engine Operation	A-3
D. Determining Cause of Shutdown	A-7
A-2. MAINTENANCE RECOMMENDATIONS	A-9
A. Lubrication Specifications	A-10
B. Fuel Specifications	A-11
C. Coolant Specifications	A-11
D. Lubrication and Maintenance	A-12
E. Electrical System	A-13
A-3. ENGINE TROUBLESHOOTING	A-14



OPERATION / MAINTENANCE MANUAL

MODEL 417B VIBRATORY HAMMER WITH MODEL 260 POWER UNIT

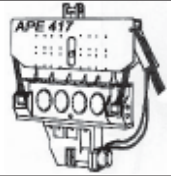

7032 SOUTH 196th - KENT, WA 98032 - (253) 872-0141 / FAX (253) 872-8710

Safety Precautions

(This list of precautions must be followed at all times to ensure personal & equipment safety.)

1. Read this manual from beginning to end before operating or working on this machine.
2. When operating in a closed area, pipe exhaust fumes outside. (**WARNING:** Breathing exhaust fumes can cause serious injury and even death.)
3. When servicing batteries, avoid any type of spark or open flame. Batteries generate explosive gases during charging. There must be proper ventilation when charging batteries.
4. Never Adjust or repair the unit while it is in operation.
5. Make sure the Control Pendant is in the "OFF" position before starting the unit.
6. Remove all tools and electrical cords before starting the unit.
7. Keep oily rags away from the exhaust system.
8. Never store flammable liquids near the engine.
9. Never stand under vibro at any time and keep your eyes on the vibro when it is in operation. Keep a look out for loose bolts or leaking hydraulic lines.
10. Avoid pulling on hose quick dis-connect fittings. Move power unit closer to work if hoses cannot reach. Do not use hoses as a tow line to tug the power unit! If a hose fails at the hydraulic couplers then it is a result of "hose tugging by the pile crew".
11. Avoid kinks in the hoses. Kinks will cut the hose safety factor by 50 percent.
12. Always wear eye and ear protection.
13. Avoid standing downwind of vibrating piles. Dirt and other matter may become airborne and fall into the unprotected eye.
14. Always wear a hardhat, gloves, and safety shoes.
15. Always attach safety line to pile when extracting or hoisting into position.
16. (**WARNING**) Never clamp vibro to pile and dis-connect from crane line. Lay vibro down on ground when not in use.
17. Do not truck power unit with quick disconnect caps and plugs screwed on to fittings unless the caps and plugs have wire rope safety lines attached. Store in storage box under control panel.



OPERATION / MAINTENANCE MANUAL

MODEL 417 VIBRATORY HAMMER WITH MODEL 260 POWER UNIT

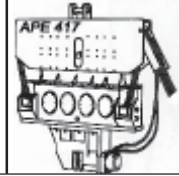

7032 SOUTH 196th - KENT, WA 98032 - (253) 872-0141 / FAX (253) 872-8710

Illustration List

Figure	Title	Page
1-A.	Machine Features	1-1
1-B.	General Description of 417 Vibro	1-3
1-C.	General Description of Suppressor Housing	1-4
1-D.	General Description of Vibratory Gearbox	1-5
1-E.	General Description of Clamp Attachment	1-6
1-F.	Clamp Attachment Hole Configuration	1-6
1-G.	Optional Attachments	1-7
1-H.	General Description of Model 240 Power Unit	1-8
2-A.	Component Identification Model 417 Vibro	2-1
2-B.	Component Identification - Model 150 Clamp	2-2
2-C.	Vibro Manifold - Supply End	2-4
2-D.	Vibro Manifold - Vibro End	2-4
2-E.	Hose Identification Model 417 Vibro	2-4
2-F.	Model 240 Power Unit Skid Identification	2-5
2-G.	Quick Disconnect Coupling Identification	2-6
2-H.	Tool Set Identification	2-7
2-J.	Caisson Clamp Identification	2-8
2-K1.	Engine Component Identification	2-9
2-K2.	Fuel Line Plumbing	2-10
2-L1.	Engine Hydraulic Component Identification	2-12
2-L2.	Gage Assembly	2-13
2-L3.	Hydraulic Schematic Diagram	2-13
2-L4.	Hydraulic Clamp Manifold Assembly	2-16
2-L5.	Hydraulic Drive Manifold Assembly	2-18
2-L1.	Control Panel Front View	2-20
2-L2.	Control Panel Internal	2-21
4-A.	Power Unit Coupler Layout	4-2
4-B.	Bleeding Clamp Attachment	4-3
7-A.	Power Unit Hydraulic Schematic	7-2
7-B1.	Electrical Schematic for Pendant Control	7-8
7-B2.	Electrical Schematic for Radio Control	7-9
7-C.	Remote Control Pendant	7-10
7-D.	Remote Control Pendant Wiring Diagram	7-11

Table List

Table	Title	Page
1-A.	Machine Specifications - Model 417 Vibro	1-2
1-B.	Machine Specifications - Model 240 Power Unit	1-2
2-A.	Component Identification . Model 417 Vibro	2-2
2-B.	Hose Identification Model 417 Vibro	2-3
2-C.	Model 240 Power Unit Skid Identification	2-4
2-D.	Quick Disconnect Coupling Identification	2-5
2-E.	Tool Set Identification	2-6
2-F.	Caisson Clamp Identification	2-7
2-G.	Engine Component Identification	2-10
2-H.	Hydraulic Component Identification	2-13
2-H1.	Hydraulic Clamp Manifold Assembly	2-16
2-H2.	Hydraulic Drive Manifold Assembly	2-18
2-I.	Control Panel and Parts	2-21
5-A.	Power Unit - Filters, Fluid Types and Capacities	5-3
6-A.	Trouble-Shooting	6-1



OPERATION / MAINTENANCE MANUAL

MODEL 417B VIBRATORY HAMMER WITH MODEL 260 POWER UNIT

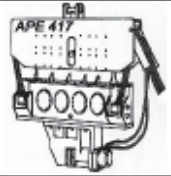

7032 SOUTH 196th - KENT, WA 98032 - (253) 872-0141 / FAX (253) 872-8710

Warranty

American Piledriving Equipment, Inc. STANDARD WARRANTY

American Piledriving Equipment, Inc. (APE/J&M) warrants new products sold by it to be free from defects in material or workmanship for a period of one year after the date of delivery to the first user and subject to the following conditions:

APE/J&M's obligation and liability under this WARRANTY is expressly limited to repairing or replacing at APE/J&M's option, any parts which appear to APE/J&M upon inspection to have been defective in material or workmanship. Such parts shall be provided at no cost to the user, at the business establishment of APE/J&M or the authorized APE/J&M distributor of the product during regular working hours. This WARRANTY, shall not apply to component parts or accessories of products not manufactured by APE/J&M and which carry the warranty of the manufacturer thereof, or to normal maintenance (scraped and skived lube and fuel lines, worn cushion material in the drive base) or normal maintenance parts (such as fouled injectors, weakened check valve springs, damaged grease fittings caused by use over time).

Replacement or repair parts installed in the product covered by this WARRANTY are warranted only for the remainder of the warranty as if such parts were original components of said product. APE/J&M makes no other warranty, expressed or implied and makes no warranty of merchantability of fitness for any particular purpose.

APE's obligation under this WARRANTY shall not include any transportation charges, costs of installation, duty, taxes or any other charges whatsoever, or any liability for direct, indirect, incidental or consequential damage or delay. If requested by APE/J&M, products or parts for which a warranty claim is made are to be returned transportation prepaid to APE/J&M. Any improper use, including operation after discovery of defective or worn parts, operation beyond rated capacity, substitution of any parts whatsoever, or parts not approved by APE/J&M or any alteration or repair by others in such manner as in APE/J&M's judgment affects the product materially and adversely, shall void this warranty.

**ANY TYPE OF WELDING ON EQUIPMENT
WILL VOID THE WARRANTY**

Refusal: Vibros: If the pile does not move one foot in 30 seconds of vibro operation (driving or pulling) at full speed. Resort to a larger vibro. APE/J&M equipment may exceed the refusal driving criteria for short periods of time as may be needed to penetrate hard soil layers or obstacles. In such cases, a heat gun is used to monitor the temperature of the bearings and related components to prevent use of the machine beyond 195 degrees F. Contact APE/J&M or your local APE/J&M distributor for special instructions when faced with refusal conditions.

Refusal: Diesels: Do not exceed 10 blows per inch or 120 blows per foot. In cases of setting of the pile it is permitted to increase the blow count to 250 blows per foot, but only for one foot of driving penetration. Pile inspectors should consult the APE factory for permission to exceed these limits. Failure to do so will void the warranty. This standard specification is accepted by the DFI (Deep Foundations Institute) and the PDCA (Pile Driving Contractors Association) and by all manufacturers of pile driving equipment.

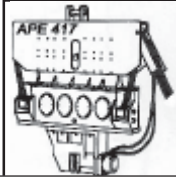

I. GENERAL INFORMATION

I-1. Machine Features

APE MODEL 417 VIBRATORY DRIVER/EXTRACTOR

FOR ALL TYPES OF PILE DRIVING AND EXTRACTING

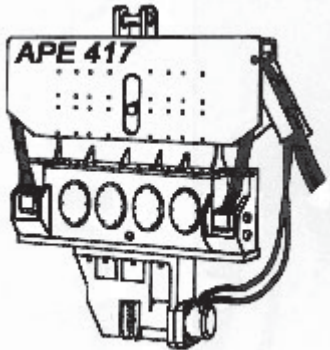

- Just 8,600 pounds
- One piece gear/eccentric design
- No pins, splines or keyways
- Eccentrics enhanced with lead
- 2,300 inch pounds - very powerful
- Visual indicator shows crane line pull
- 40 US Ton line pull maximum
- Can mount and operate off backhoe
- Can be used under water
- Drives double & single sheets
- 4 wire hoses prevent failures
- Clamp fits H-beams & plates
- 83 US Tons of drive force
- Motor recessed - out of harm's way
- Attachments for wood & pipe piles

APE MODEL 240 & 260 POWER UNIT

HYD POWER SOURCE FOR VIBROS, AUGERS, DECK WINCHES, HYD. IMPACT HAMMERS, ETC.

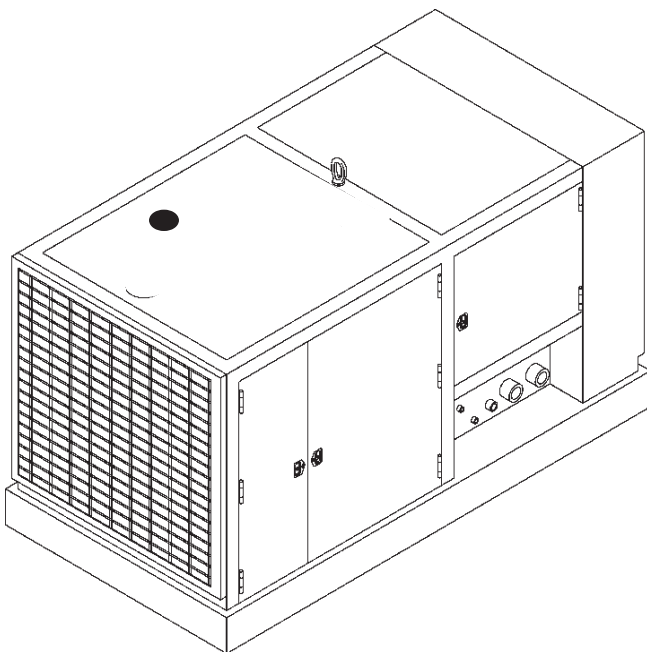

- Cummins engine
- 240 (193kW) horsepower (now 260 hp)
- Lockable sheet metal enclosure
- 5000 (345bar) psi system
- Complete tool box provided
- Bi-directional flow for auger work
- 50 foot (15m) electric pendant
- Backup controls mounted on panel
- Engine safety shutdowns built in
- Sound reduction by design
- Easy to change hydraulic filters
- One loop hydraulic system
- Large cooler keeps oil temp down
- Enough power to run larger vibros
- Radio control available

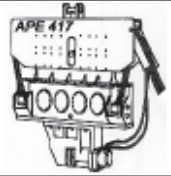

I. GENERAL INFORMATION (Continued...)

I-2. Machine Specifications

I-2A. Model 100 Vibro - (Table 1-A.)

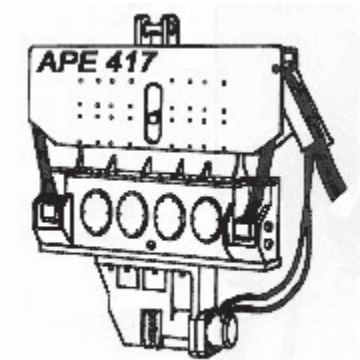

Eccentric Moment	2,300 in-lbs (26.6kgm)
Drive Force	83 USTons (738 kN)
Frequency (cpm)	400 - 1,670 vpm
Amplitude	Up to 1" (25.4mm)
Line Pull for Extraction	60 US Tons (533 kN)
Hydraulic Hose Length	100' (30 m)
Suspended Weight*	7,900 lbs. (3,590 kg)
Length	84" (213 cm)
Width at throat	14" (35.5 cm)
Height*	94" (238 cm)

* Weight and height includes sheeting clamp and 1/2 of hose bundle.

I-2B. Model 260 Power Unit - (Table 1-B.)

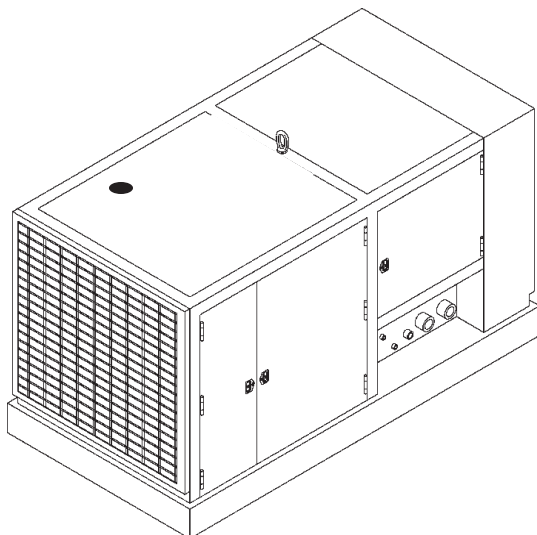

Engine	Cummins 6CT
Maximum Power	260 hp
Operating Speed	2200 to 2400 rpm
Maximum Drive Pressure	5000 psi (345 bar)
Max.Hyd.Flow-Forward	80 gpm (303 lpm)
Max.Hyd.Flow-Reverse	80 gpm (303 lpm)
Clamp Pressure	5000 psi (345 bar)
Clamp Pump Flow	10 gpm (38 lpm)
Weight	11,000 lbs (4,990 kg)
Length	102" (259 cm)
Width	50" (127 cm)
Height	60" (152.4 cm)

**Dimensions may vary depending on the year and model.
Consult the factory for certifications on unit being used.**

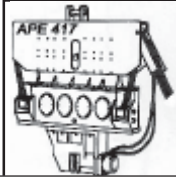

I. GENERAL INFORMATION (Continued...)

I-3. General Description of Model 100 Vibro

The **APE Model 417** is a variable frequency vibratory pile driver/extractor designed to drive and extract all types of piles including sheet, pipe, timber, concrete, H-beam, I-beam, and steel plates. In addition, the vibrator can be used for soil compaction, installing well casings, and installation of tie-backs and wick drains.

The Model 417 operates in a frequency range of 400 to 1,670 cycles per minute depending on the hydraulic flow and on the hydraulic motors fitted to the gear train. The Model 417 is especially suited for driving or extracting piles that are near buildings or other structures. This is because the Model 417 vibrates at higher frequencies and thus is less damaging to surrounding soils.

The three major parts to the Model 417 are as follows:

- A.) The Suppressor housing.
- B.) The Gearbox.
- C.) The Clamping Attachment.

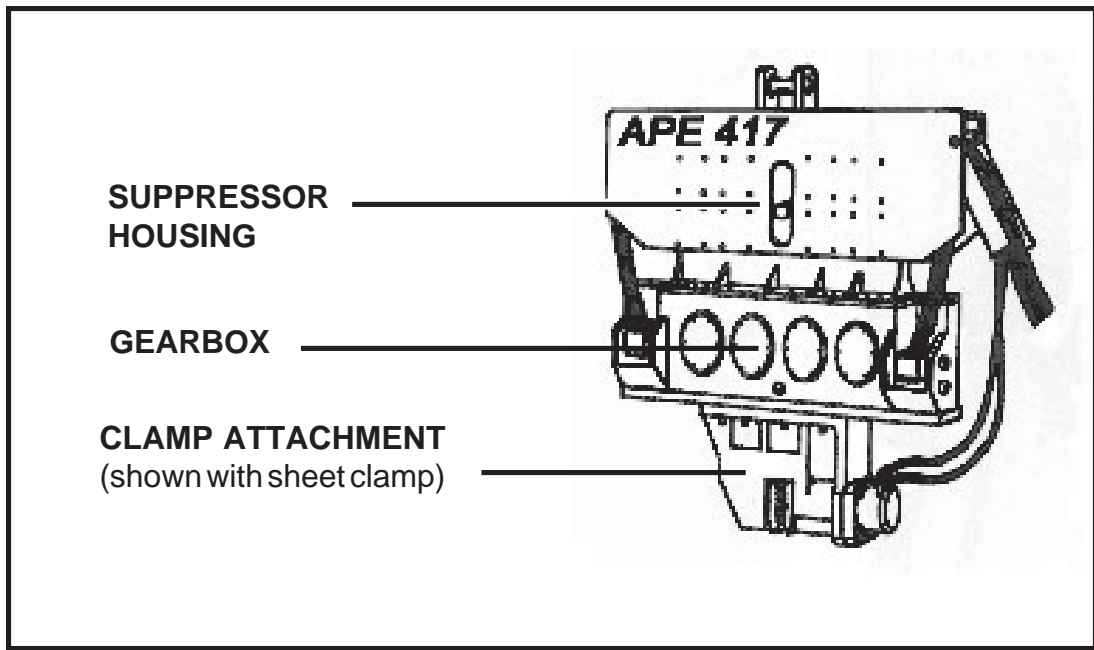
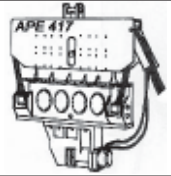

Figure 1-B. General Description of 417 Vibro.



I. GENERAL INFORMATION (Continued...)

I-3A. The Suppressor Housing

The suppressor housing of the **Model 417 APE Vibrator** is the top part of the vibro that attaches to the crane line. It is designed to absorb the vibration generated from the vibrator gearbox. The suppressor housing consists of eight rubber elastomers. The rubber elastomers are used during all driving operations and light to medium extraction. Each elastomer delivers one ton of line pull for each inch of travel. ***The suppressor housing is rated at 40 Tons maximum. (WARNING! Hard pulling for long periods of time will heat and damage the elastomers. The heat generated from constant heavy line pull will destroy the chemical bond between the rubber and mounting plate which will cause the elastomer to fail.)*** When engaged in hard extracting, break every 15 minutes to allow elastomers to cool.

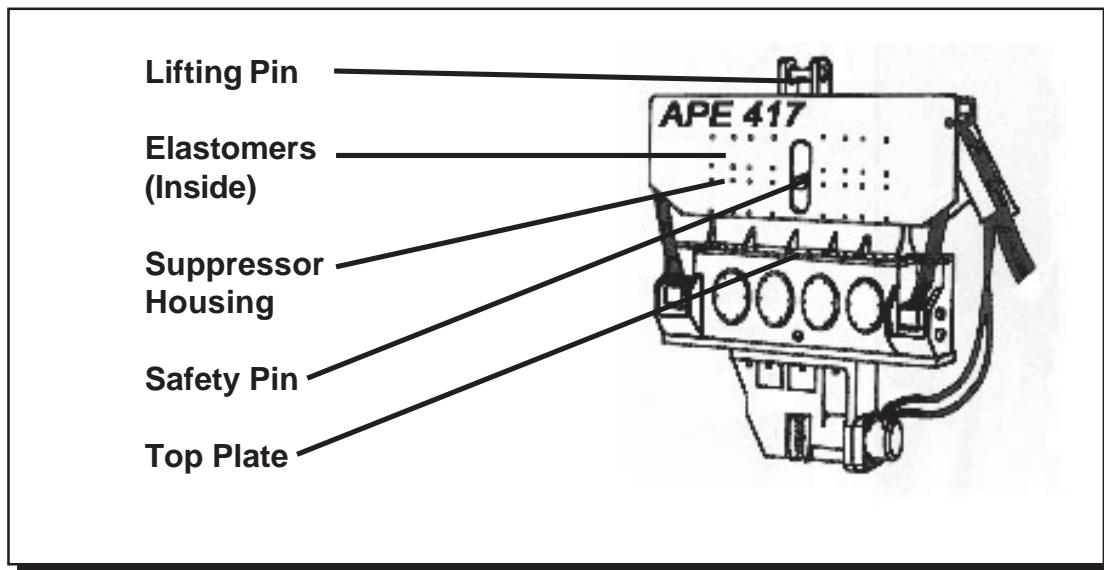
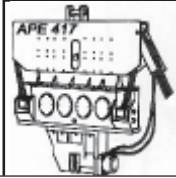

Figure 1-C. General Description of Suppressor Housing.



I. GENERAL INFORMATION (Continued...)

I-3B. The Vibrator Gearbox

The vibrator gearbox contains two high amplitude eccentric weights cast in one piece with the gear. The counterweight is filled, and therefore, enhanced with lead to increase eccentric moment. This design is unique to the industry and was developed by the engineers of APE to solve a number of problems associated with other types of vibrator machines. Both the eccentric and the drive gear have been helically cut to provide high speed operation with reduced noise and wear. Vibration is caused by the vertical movement created when the eccentrics are rotated. The eccentric and drive gear are driven in line by one Volvo motor mounted on the outside face of the gearbox. The motor is recessed for maximum protection. The eccentrics rotate on two shafts housed by four giant spherical bearings. The gears and bearings receive lubrication as a result of the fluid splashing inside the gearbox when the gears are rotated. The oil level is quickly determined by looking at the site gauge. The Model 417 can be operated under water to a depth of 30 feet without modifications. (Consult factory for depths below 30 feet.)

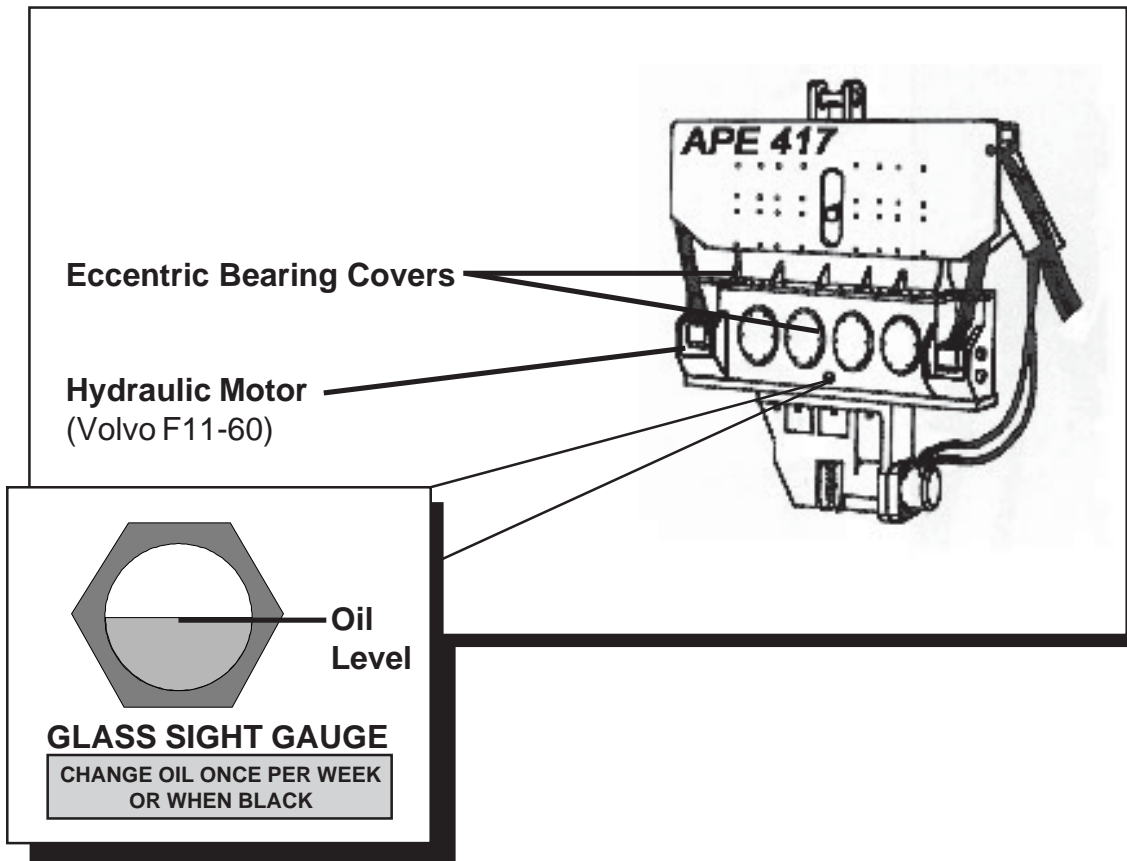
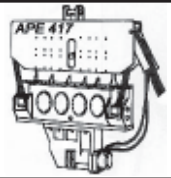

Figure 1-D. General Description of Vibrator Gearbox.



I. GENERAL INFORMATION (Continued...)

I-3C. The Clamp Attachment

The APE 417 comes with a **standard sheet pile clamp attachment**. The clamp contains two gripping jaws. One is "fixed" and one is "moveable." A large hydraulic cylinder operates the moveable jaw with up to 250 tons of clamping force depending on clamp pump relief pressure. The jaws open and close by turning a switch on the remote control pendant or may be operated by turning the switch at the main control panel mounted behind one of the doors on the power unit. The valve can be manually operated with a screwdriver if all electrical fails. **The APE standard sheet pile clamp** can be fitted with jaws to fit many different types of piles including sheet piles, H-Beams, steel plates, steel rods, pipe piles, wood piles, and concrete piles. (Contact APE or your local APE distributor for more information on clamp attachments for special pile types.)

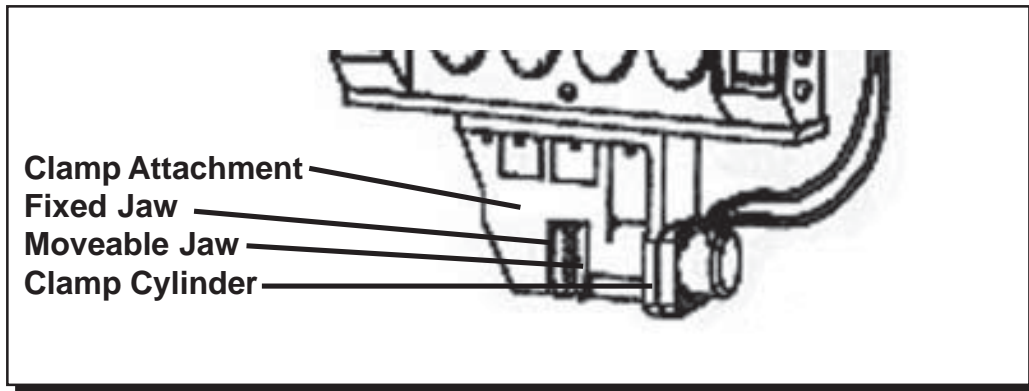

Figure 1-E. General Description of Clamp Attachment.

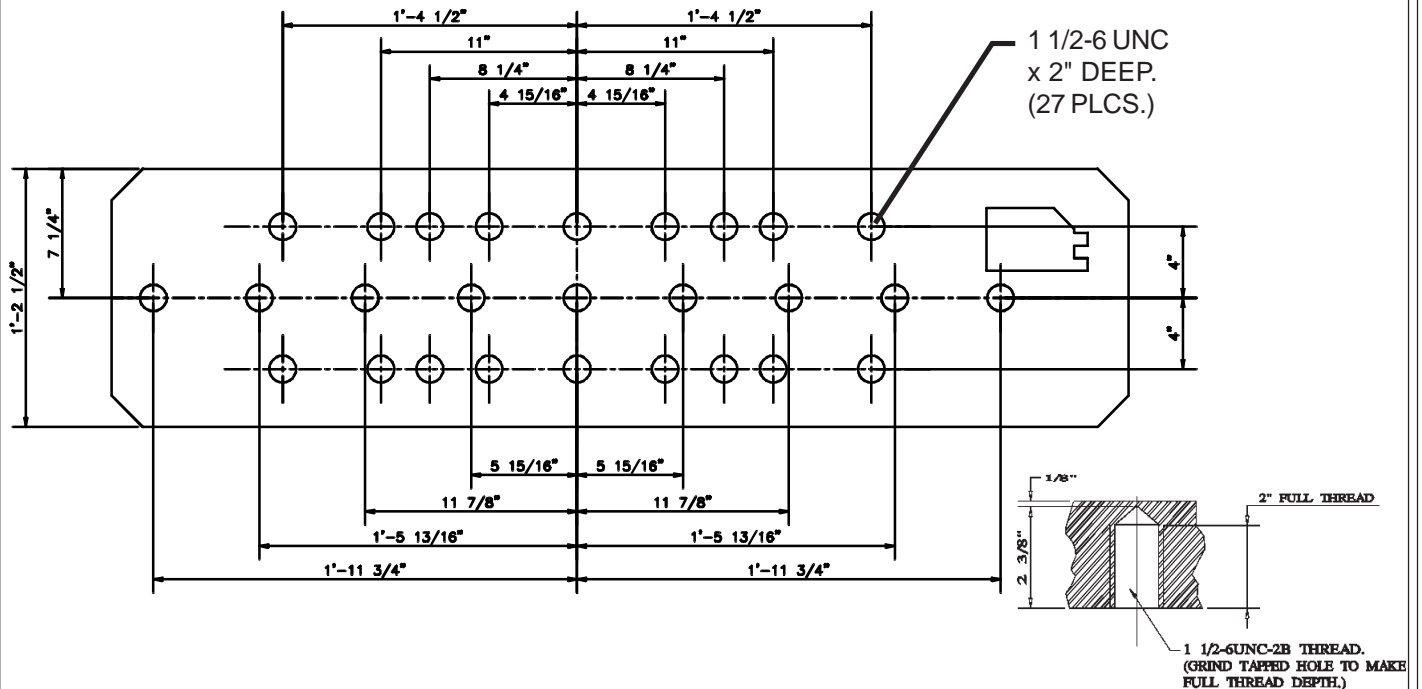
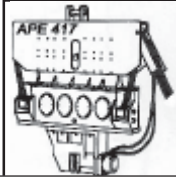

Figure 1-F. Clamp Attachment Hole Configuration.



I. GENERAL INFORMATION (Continued...)

I-3D. Optional Attachments

The following are some of the optional attachments for the APE Vibratory Hammers. (Contact APE or your local APE distributor for more information about these and other available equipment.)

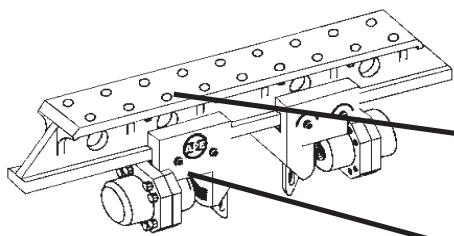

- 7 ft. Caisson Beam (#901000)
- 8 ft. Caisson Beam (#902000)
- 11ft. Caisson Beam (#903000)
- Caisson Clamp (#250000)

APE CAISSON CLAMP

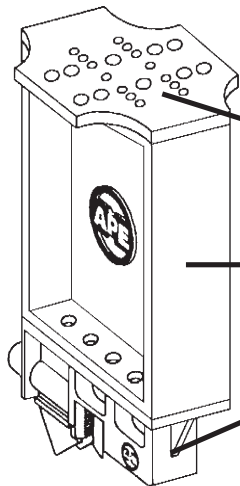

- 90 Degree Adapter Plate (#905000)
- 4 ft. Extension Adapter (#906000)
- Clamp Attachment

APE 90 DEGREE ADAPTER WITH EXTENSION

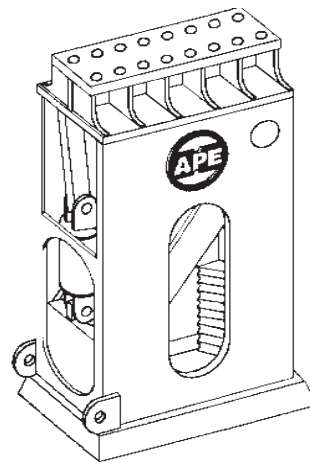

APE DELUXE CONCRETE / WOOD CLAMP (#907000)

Figure 1-G. Optional Attachments

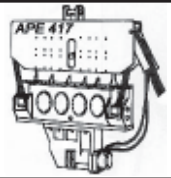

I. GENERAL INFORMATION (Continued...)

I-4. General Description of Model 240 & 260 Power Unit

The Model 417B vibrator runs off the APE 260 power unit. The APE 240 has a 244 horsepower CUMMINS 6C engine. The engine is mounted to a tubular frame that also serves as a diesel fuel tank. A sheet metal and tube frame covers the engine and is equipped with locking doors for protection from the environment. Equipment attached to the Power Unit can be controlled from the Main Control Panel (located behind one of the doors), the 50 foot Pendant switch, or the Radio Control (400 ft. radius). Each of the two powered hydraulic circuits are driven by separate pumps. There are three hose connections in the Drive circuit (Pressure, Return, and Case Drain), and two hoses in the Clamp circuit. The quick disconnect fitting for each hose is different, so the hoses cannot be connected in the wrong location.

WARNING: Clean with ether or a clean rag before installing quick disconnects. Make sure you seat the quick disconnect fittings all the way tight. Failure to tighten the quick disconnects will stop the flow of oil and will prevent the vibro from operating. Failure to tighten the clamp fittings completely tight will cause the jaws to either not open or not close. If this happens you may have to crack the fitting and bleed off the pressure to release the quick dis-connects.

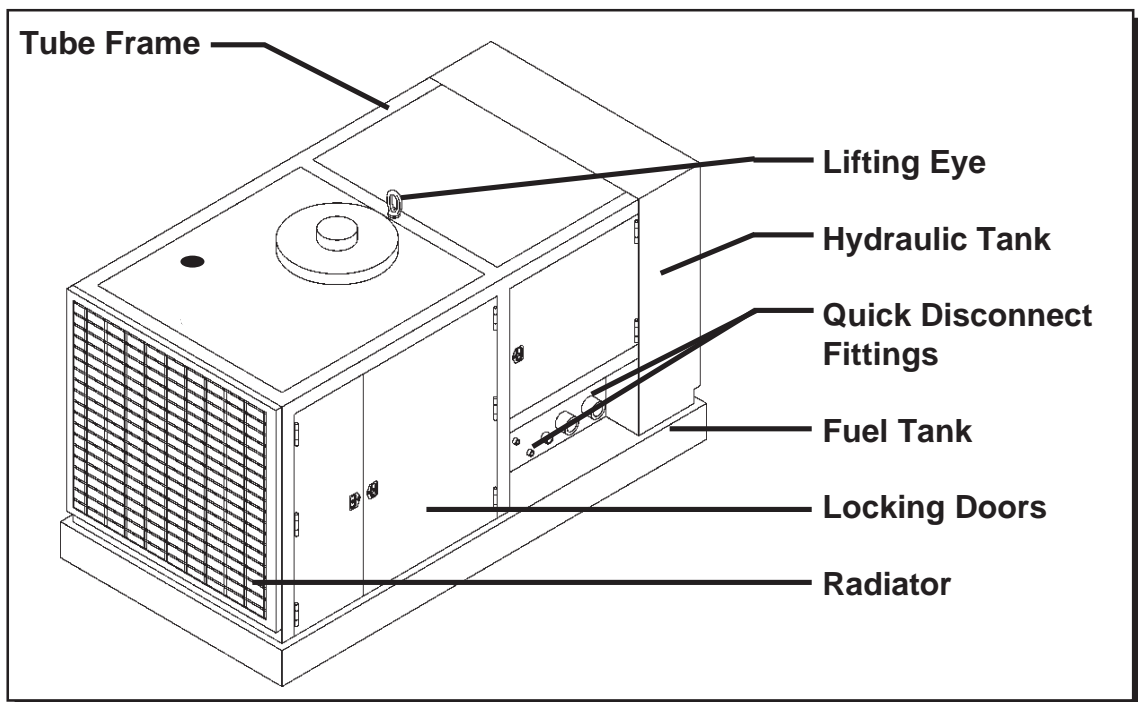
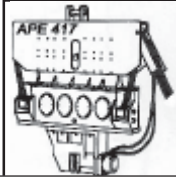

Figure 1-H. General Description of Model 240 Power Unit



II. COMPONENT DEFINITION

II-1. Component Identification - Model 417 Vibratory Hammer

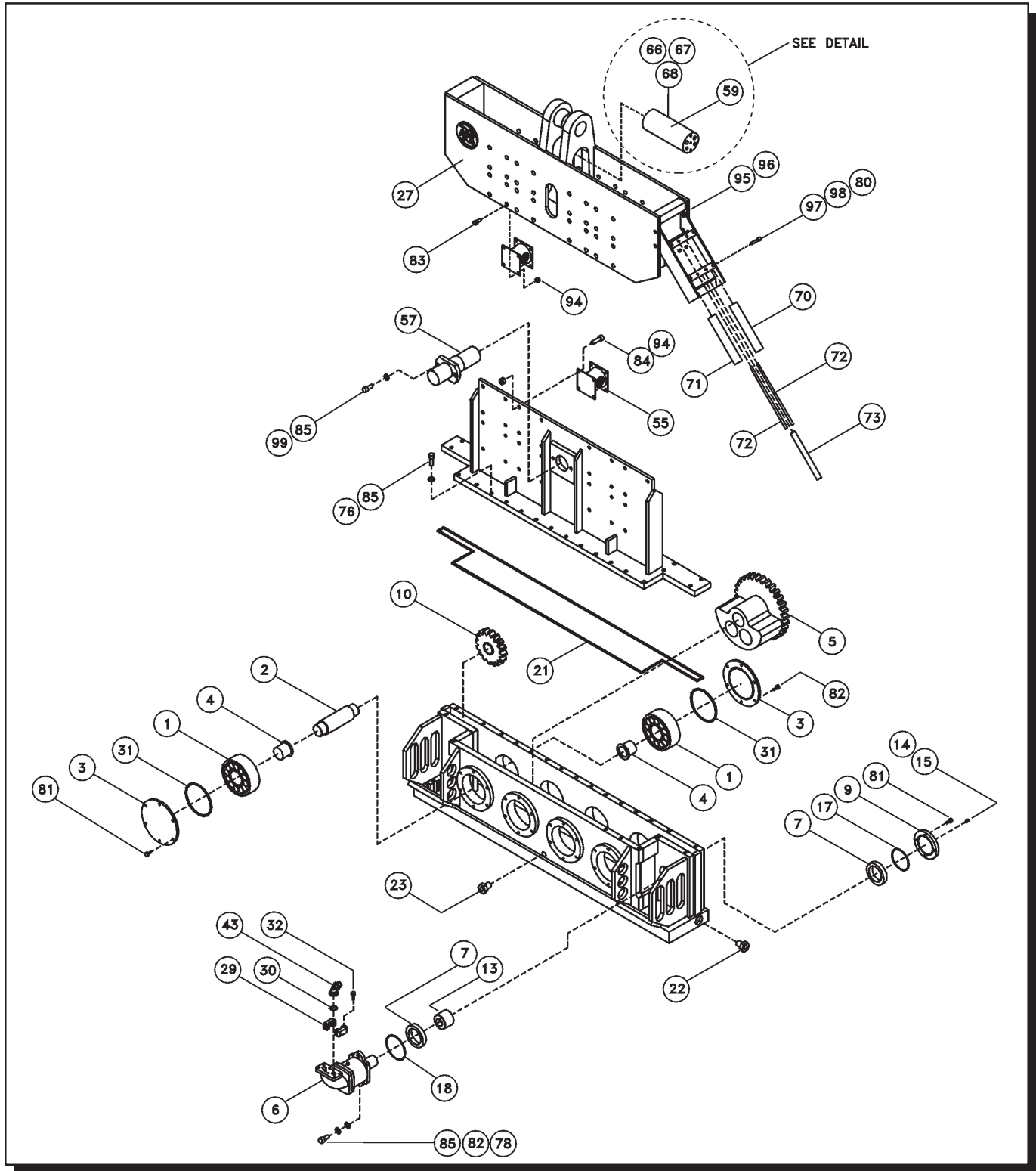
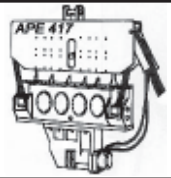

Figure 2-A. Component Identification.



II. COMPONENT DEFINITION

II-1. Component Identification - Model 417 Vibratory Hammer, Continued.

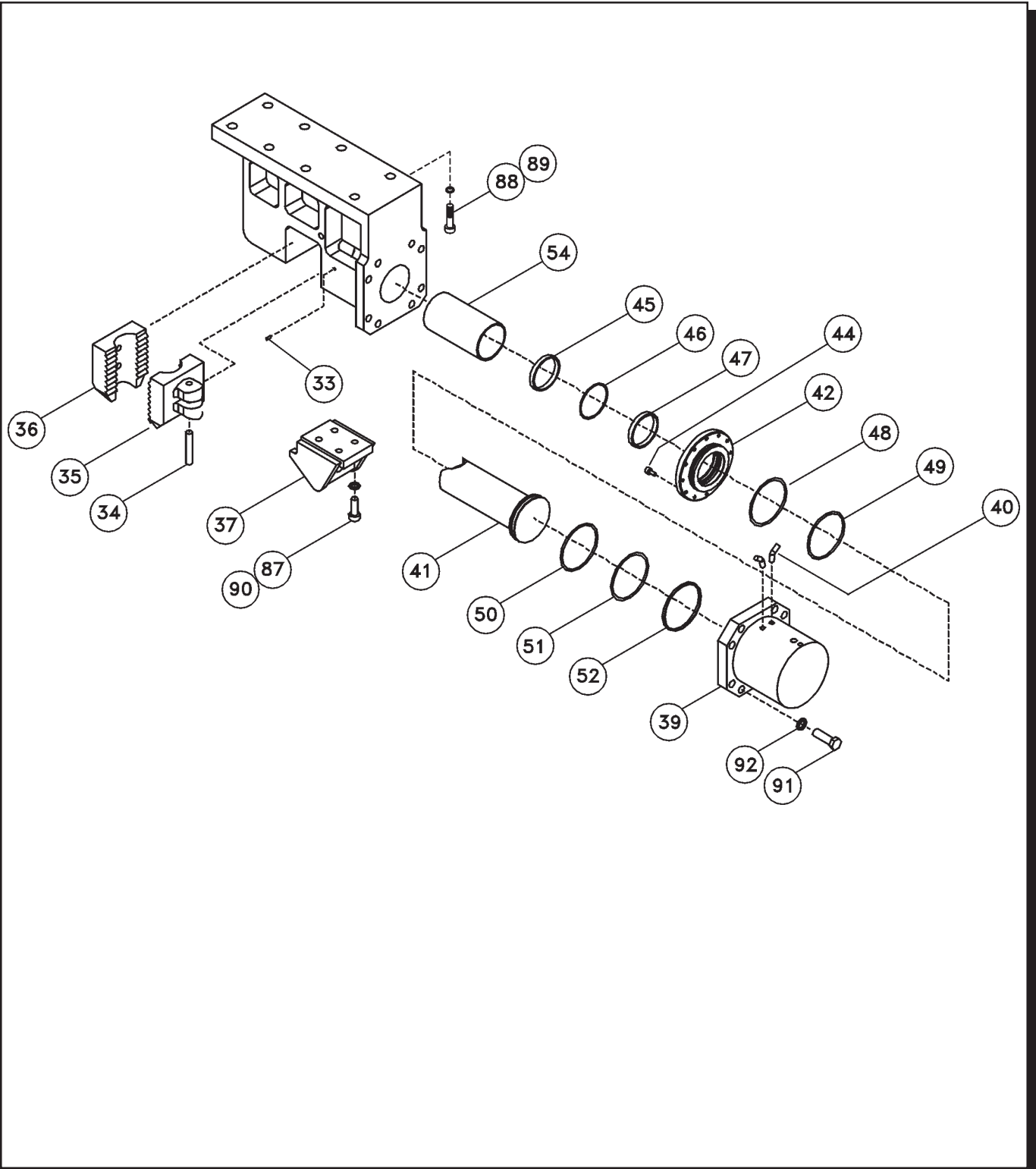
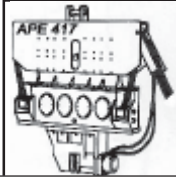

Figure 2-B. 150 Clamp Component Identification.



OPERATION / MAINTENANCE MANUAL

MODEL 417 VIBRATORY HAMMER WITH MODEL 260 POWER UNIT



7032 SOUTH 196th - KENT, WA 98032 - (253) 872-0141 / FAX (253) 872-8710

II. COMPONENT DEFINITION (Continued...)

II-1. Component Identification

The following is a general listing of the APE 417 major components and part numbers. (Please see Figure 2-A. for component location.)

Table 2-A. Component Identification

Item	Qty	Description	Part #	Item	Qty	Description	Part #
1	8	Model 417B Eccentric Bearing	#721001	48	1	Parker O-Ring #2-367	#
2	4	Eccentric Shaft	#	49	1	Parbak #8-367	#
3	8	Eccentric Bearing Cover	#	50	1	R5100-128	#
4	4	Eccentric Bearing Sleeve	#	51	1	EXP #442	#
5	4	Eccentric Weight	#721007	52	1	Parker Wear Ring W2-8000-750	#
6	2	Vibratory Motor, Volvo F11-60	#	53			#
7	4	Motor Bearing	#7100161	54	1	Plastic Insert Sleeve	-----
8	2	Fitting#F40X-S-8-12MJICxMBSPP	#	55	16	Small Elastomers	#321004
9	1	Motor Bearing Cover	#	56	--	-----	-----
10	2	Drive Gear	#722006	57	1	Center Pin	#
11				58	--	-----	-----
12				59			#
13	2	Gear Carrier	#722010	60	1	Pop-Off Valve	#321009
14	2	#10 SAE Breather Plug	#122014	61	1	Check Valve ??	#311015
15	2	Breather Valve	#112015	62	2	#12 PIPE #12 JIC Fitting ??	#421016
16			#	63	6	#6 PIPE #6 JIC Fitting ??	#421017
17	1	Motor Cover O-Ring	#	64	2	Danger Sticker - Small	#000109
18	2	Motor O-Ring	#	65	2	CAP #6 JIC ??	#123011
19	1	Vibratory Gearbox	#	66	1	Hose, Suppressor, Case Drain	#
20			#	67	2	Hose, Suppressor, Clamp	#
21	1	O-Ring .125 C/S VITON 90 Cord	#	68	2	Hose, Suppressor, Motor Feed	#
22	1	Magnetic Drain Plug	#123004	70	1	Hose, Motor Feed	#
23	1	Sight Glass	#123005	71	1	Hose, Return	#
24			#	72	2	Hose, Pigtail, Clamp	#
25	1	Oil Fill Plug	#	73	1	Hose, Case Drain	#
26	1	Inner Suppressor	#	76	--	SHCS 3/4"NC x 2 3/4" (M20-2.5x60)	#124101
27	1	Outer Suppressor Housing	#	78	--	SHCS 5/8"NC x 1 3/4" (M20-2.5x50)	#
28			#	80	--	Lockwasher 5/8" High Collar (M18)	#114115
29	4	Code 62 Split Flange x 3/4"	#	81	--	SHCS 1/2"NC x 1" (M14-2.0x25)	#114107
30	4	Flange O-Ring #	#	82	--	SHCS 1/2" NC x 3/4"	#
31	1	Bearing Cover O-Ring #	#113101	83	--	SHCS 3/4"NCx1 3/4" (M18-2.5x45)	#124101
32	8	3/8 Hex Bolt x 1 1/2"	#	84	--	SHCS 3/4"NCx2 1/4" (M18-2.5x60)	#
33	1	1/8" Grease Zert	#211001	85	--	Lockwasher 3/4" High Collar (M20)	#114105
34	1	Jaw Pin	#211002	87	--	1" Lockwasher - High Collar (M24)	#114207
35	1	Movable Jaw	#211005	88	--	SHCS 1 1/2" x 3 1/2" (M36-4.0x80)	#114201
36	1	Fixed Jaw	#211011	89	--	1 1/2" Lockwasher - High Collar (M36)	#114202
37	1	Sheet Pile Guide Assy.	#211017	90	--	SHCS 1" NC x 3"	#114208
38	1	Clamp Body	#	91	--	Bolt 1 1/4"NF X 3 1/3" GR 8 Hex (M33-3.5x100)	#114204
39	1	Clamp Cylinder - Model 150	#212001	92	--	1 1/4" Lockwasher - High Collar (M36)	#
40	2	#6 SAE 45Deg. Fitting	#222015	93	--	SCHS 3/4" NC x 1"	#
41	1	Plunger (Rod & Piston)	#	94	--	3/4" Stover Nut	#
42	1	Cylinder Gland	#212302	95	--	Bolt 7/8" x 2 3/4" Hex GR 8	#
43	4	#6 SAE Flange-JIC 45 Deg.	#	96	--	7/8" Nylon Nut	#
44	--	Bolt-SHCS 5/8"NF x 1"	#114209	97	--	SHCS 5/8 x 4 1/2"	#
45	1	Parker Wiper Ring SH959-53	#	98	--	5/8 Hex Nut	#
46	1	Parker Polypak 2500-6000-375B	#	99	--	SHCS 3/4" x 2" GR 8	#
47	1	Molygard Wear Ring W2-6250-750	#				

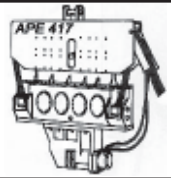

II. COMPONENT DEFINITION

II-2. Component Identification - Model 417 Vibro Manifold

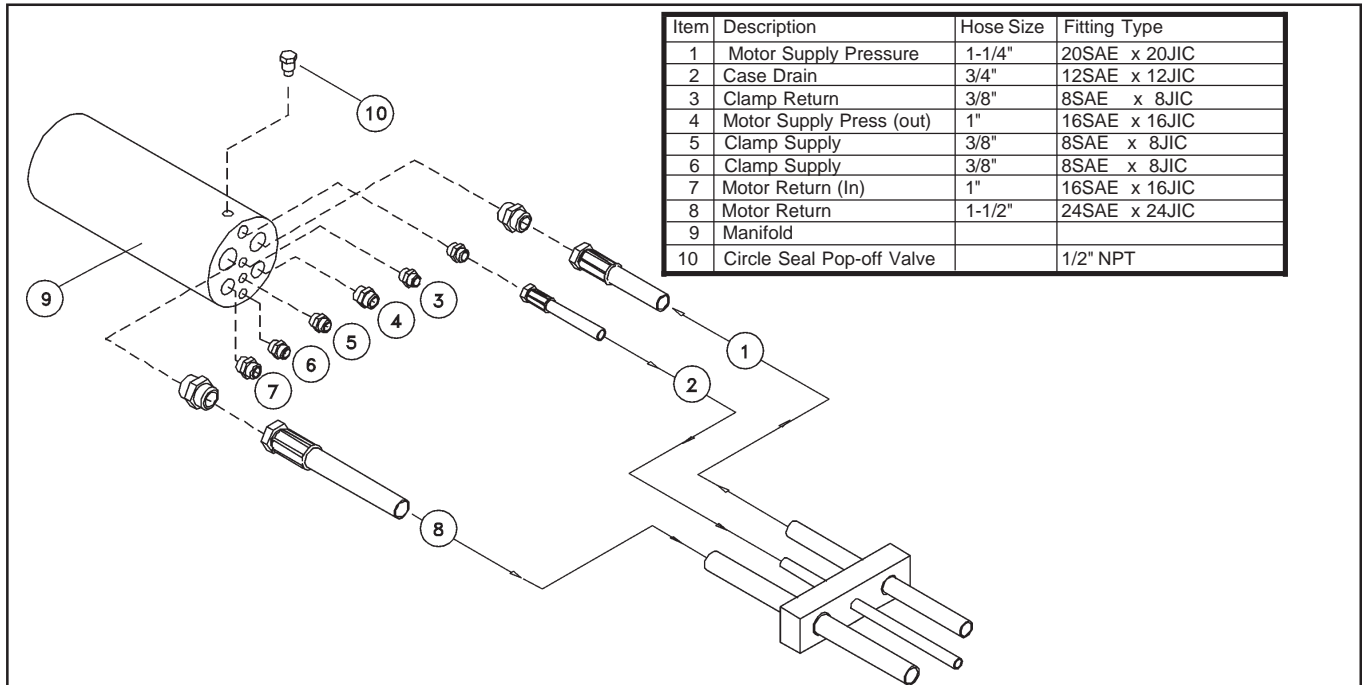

Figure 2-C. Vibro Manifold - Supply End

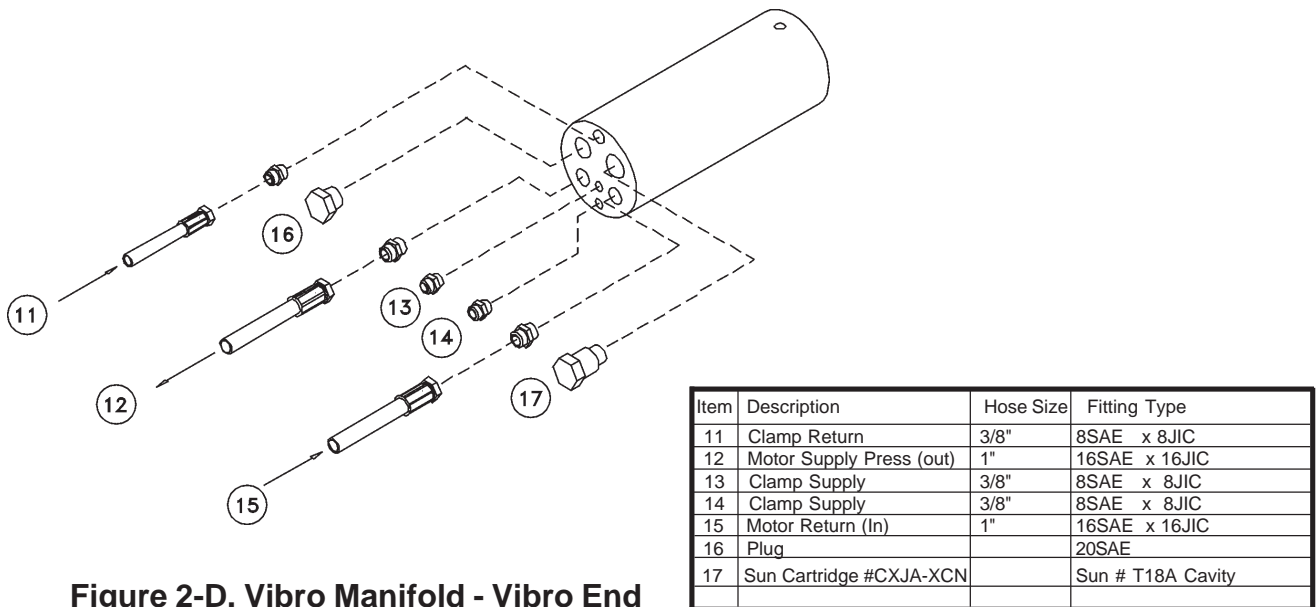
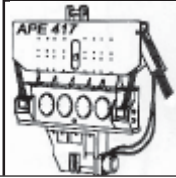

Figure 2-D. Vibro Manifold - Vibro End



OPERATION / MAINTENANCE MANUAL

MODEL 417 VIBRATORY HAMMER WITH MODEL 260 POWER UNIT



7032 SOUTH 196th - KENT, WA 98032 - (253) 872-0141 / FAX (253) 872-8710

II. COMPONENT DEFINITION (Continued...)

II-3. Hose Identification

The following is a general listing of the standard hoses that are shipped with the Model 100 Vibratory Hammer. (Please see Figure 2-B. for component location.)

Table 2-B. Hose Identification

Item	Qty	Description	Part #
1	2	1" Grey hose x 50'	#411010
		1" Hose #100R12	
2	2	1" Grey Hose x 50'	#411010
		1" Hose #100R12	
3	2	3/4" Two Wire Hose x 50'	#421009
		3/4" 100R2AT w/ #HU1212NJ Ea. End	
4	4	3/8" Gates Hose x 50'	#421010
		w/ #HU66NJ Ea. End	
5	1	Fitting #6 JIC Male/#6 Female	#421011
6	4	Fitting #24 Male JIC Union	#421012
7	2	Fitting #12 Male JIC Union	#421013
8	6	Fitting #6 Male JIC Union	#421014
9	2	Fitting #16 JIC x #16 Pipe	#421018

Item	Qty	Description	Part #
10	1	Fitting#12 JIC/#12 Pipe	#421016
11	1	Fitting #6 JIC/#6 Pipe	#421017
12	1	Aeroquip Dust Cap #5100S712B	#421021
13	1	Aeroquip Male Q.D. #5100S112B	#421020
14	2	Safeway Female Q.D. #S35-3	#421024
15	2	Safeway Male Q.D. #S31-3	#421025
16	2	Safeway Cap #S39-3	#421026
17	2	Safeway Plug #S34-3	#421027
18	2	Q.D. Hydraulic Female Coupling	#400301
19	2	Q.D. Hydraulic Male Coupling	#400303
20	1	APE Dust Plug	#400704
21	1	APE Dust Cap	#400703
22	2	Reducer #24 Pipe/#16 Pipe	#411045

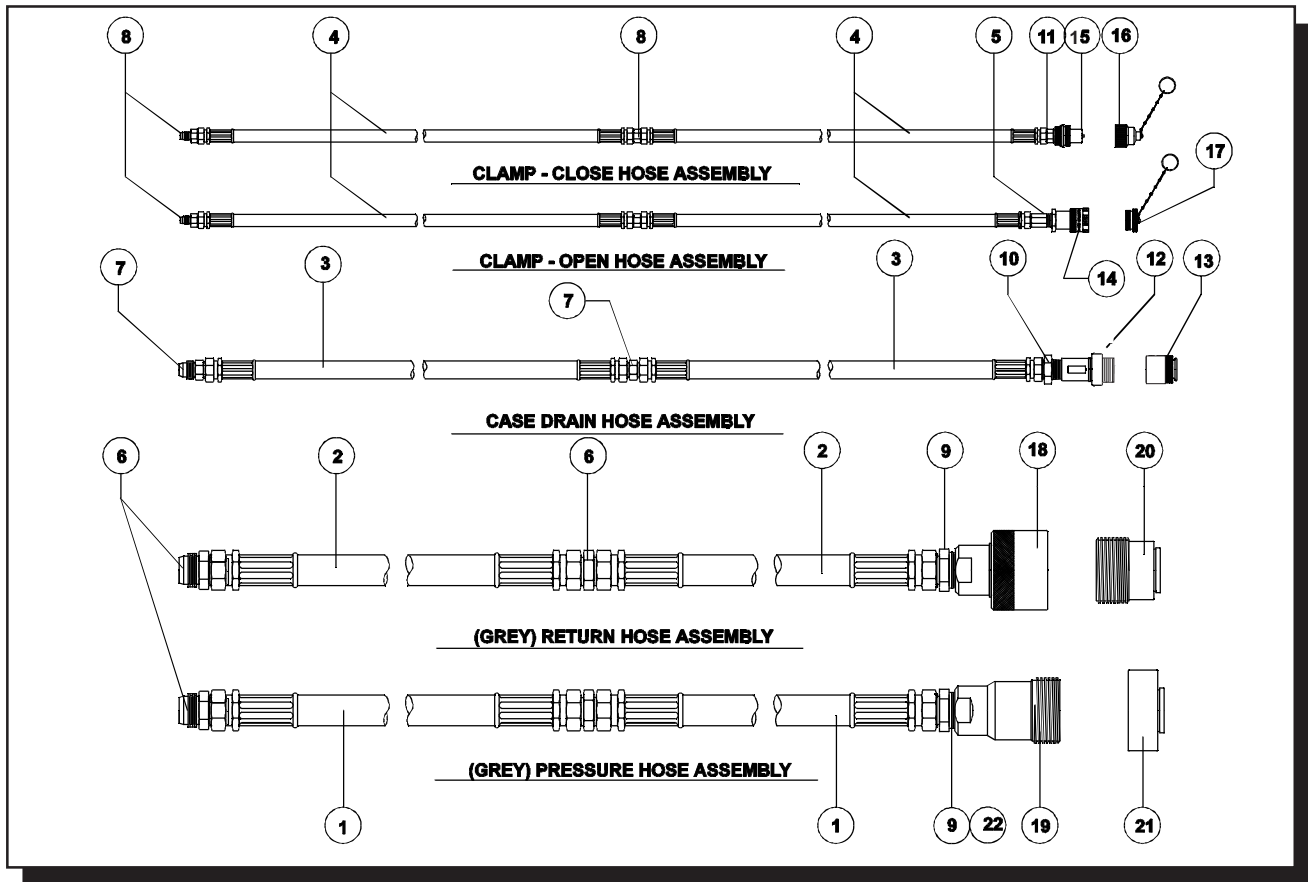
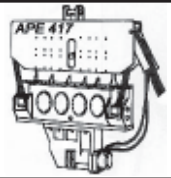

Figure 2-E. Hose Bundle Identification



II. COMPONENT DEFINITION (Continued...)

II-4. Model 260 Power Unit Skid Identification

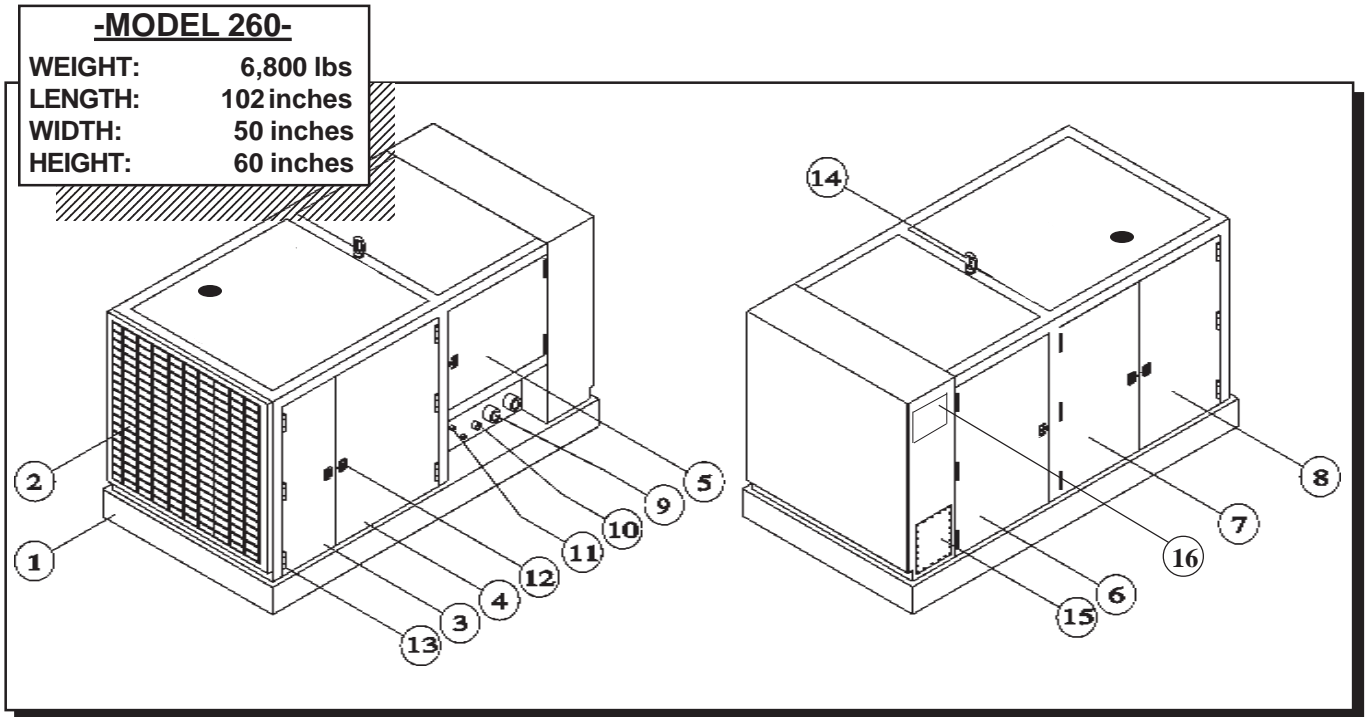
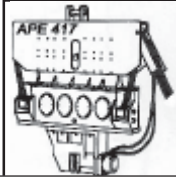

Figure 2-F. Model 240 Power Unit Skid Identification

Table 2-C. Model 240 Power Unit Skid Identification

Item	Qty	Description
1	1	Model 240 Power Unit Skid
2	1	Radiator Grill
3	1	Door 21 1/2" x 51 1/2"
4	1	Door 45 3/4" x 51 1/2"
5	1	Door 21 1/2" x 20"
6	1	Door 21 1/2" x 51 1/2"
7	1	Door 33 5/8" x 51 1/2"
8	1	Door 33 5/8" x 51 1/2"
9	2	1 1/2" Hydraulic Coupling
10	1	3/4" Hydraulic Coupling
11	2	3/8" Hydraulic Coupling
12	6	Door Handle / Lock
		Lock-#EMC 56462W Two Point Lock
		Handle-#EMC 48742W Locking Handle
13	17	Hinges #R140-150 Weld On Hinge
14	1	Lifting Eye Nuts - Crosby Laughlin #6-400 #10
15	1	Access Cover Plate 15" x 18"
16	1	Access Cover Plate 12" x 15"



II. MAJOR COMPONENT DEFINITION (Continued...)

II-5. Quick Disconnect Couplings

The APE Quick Disconnect Couplings are high pressure hydraulic couplings designed for rugged applications. Service in many such applications has proven the design compatible to extreme pressures, structural and system induced shock loads. The construction of the coupling assembly promotes ease of use and maintenance.

Design Features:

- Excellent flow characteristics for continuous duty applications.
- High strength design endures high surge and shock conditions.
- Flat crested stub-ACME threads and all steel construction withstand storage and rig-up damage.
- Structurally compatible with weight of 5,000 P.S.I. flex-hose and system induced shock loads.

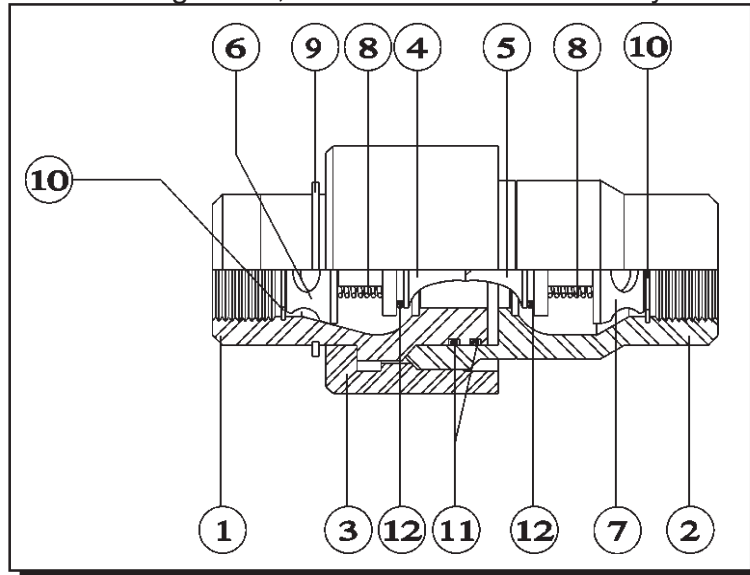
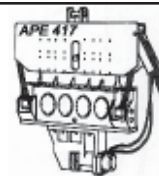

Figure 2-G. Quick Disconnect Coupling Identification

Table 2-D. Quick Disconnect Coupling Identification

Item	Qty	Description
1	1	Q.D. Hydraulic Female Coupling #400301
2	1	Q.D. Hydraulic Male Coupling #400303
3	1	Q.D. Hydraulic Coupling Sleeve #400302
4	1	Q.D. O-Ring Carrier "A" #400202
5	1	Q.D. O-Ring Carrier "B" #400201
6	1	Q.D. Plunger #400101
7	1	Q.D. Plunger #400101
8	1	Q.D. Plunger Spring #400701
9	1	Retaining Ring - "Inverted External" #I-275
10	2	Retaining Ring - "Truarc Internal" #N5000-168
11	2	Parker O-Ring #2-230 & One Parback
12	2	Parker O-Ring #2-216



II. MAJOR COMPONENT DEFINITION (Continued...)

II-6. Tool Set Identification

Mounted inside the **Model 260 Power Unit** is a set of tools frequently used for the maintenance of the **APE Model 100 Vibratory Hammer**. The following figure and table shows the location and the use for each tool.

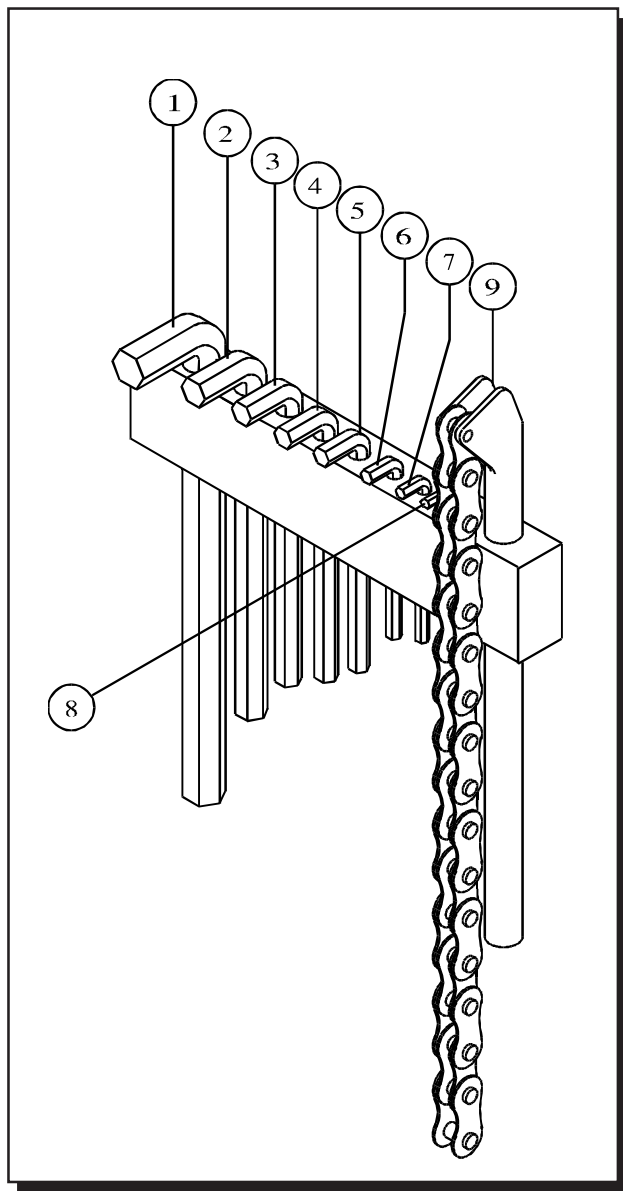
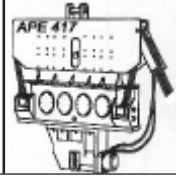

Figure 2-H. Tool Set Identification

Table 2-E. Tool Set Identification

ITEM	QTY	DESCRIPTION	PART#
1	1	1" Allen Wrench	#50004
For use with the clamp attachment bolts			
2	1	3/4" Allen Wrench	#50006
For use with clamp fixed jaw, sheet guide			
3	1	5/8" Allen Wrench	#95007
For hydraulic motor, drain plug, top plate			
4	1	9/16" Allen Wrench	#50013
For use with the hose bracket bolts			
5	1	1/2" Allen Wrench	#50008
6	1	3/8" Allen Wrench	#50009
For use with bearing cover bolts			
7	1	5/16" Allen Wrench	#50014
For use with the hose bracket bolts			
8	1	1/4" Allen Wrench	#50015
For use with the vibro oil level check			
9	1	Chain Wrench	#50011
Used to tighten the quick disconnects			



II. MAJOR COMPONENT DEFINITION (Continued...)

II-7. Caisson Clamp Identification.

The following is a general listing of the parts for the APE Caisson Clamp and Beams. (Please see Figure 2-F. for component location.)

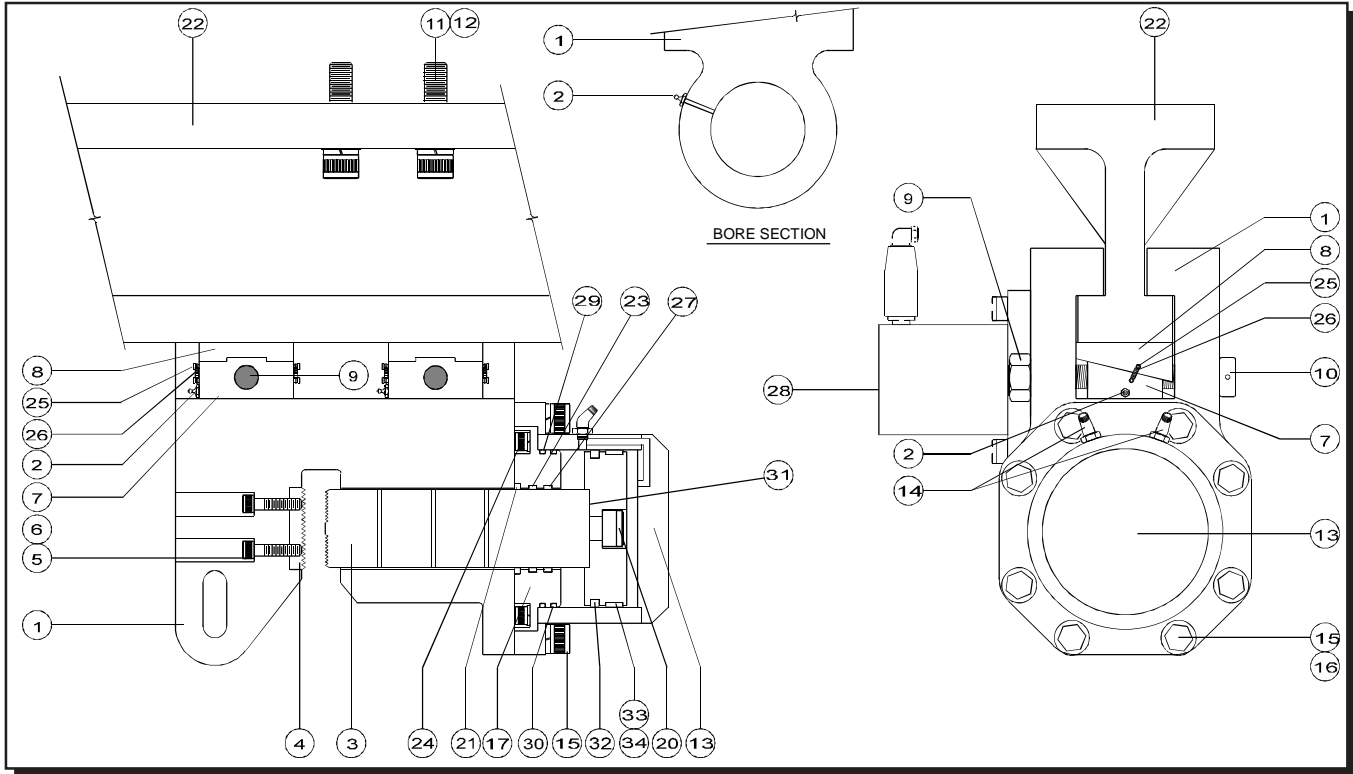
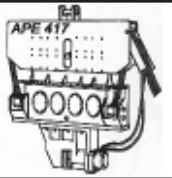

Figure 2-J. Caisson Clamp Identification.

Table 2-F. Caisson Clamp Identification

Item	Qty	Description	Part #
1	1	Caisson Clamp Body	#250101
2	6	Grease Zert	#221001
3	1	Caisson Clamp Plunger/Jaw	#250301
4	1	Caisson Clamp Fixed Jaw	#250202
5	2	Bolt - SHCS 5/8" x 4"	#124214
6	2	Lock Washer 5/8" High Collar	#124115
7	2	Male Wedge Half	#243102
8	2	Female Wedge Half	#243105
9	2	Wedge Bolt w/Washer	#124211
10	2	Wedge Nut w/Washer	#124212
11	17	Bolt - SHCS 1 1/2" x 3 1/2"	#124201
12	17	Lock Wa. - 1 1/2" High Collar	#124202
13	1	Clamp Cylinder	#250001
14	2	#6 SAE/#6 JIC 45 Deg. Fitting	#222002
15	8	Bolt - SHCS 1 1/4" NF x 3 1/2" GR.8	#124204
16	8	Lock Wa. - 1 1/4" High Collar	#124205
17	1	Cylinder End Cap	#250302

Item	Qty	Description	Part #
18	1	Cylinder Piston	#250303
19	1	Plunger	#250301
20	1	Bolt - SHCS 1 1/2-8 x 3"	#250304
21	1	Wiper - #959-41	#
22	1	Caisson Beam 11ft.	#903000
23	1	Poly Seal - #2500-4500-375B	#
24	12	Bolt - SHCS 5/8-18 x 1"	#
25	8	Spring Pin	#250103
26	4	Wedge Spring	#250104
27	1	Wear Ring - #W2-4750-750	#
28	1	Hydraulic Wedge Activator Kit	#243100
29	1	Parker O-Ring #8-367	#
30	1	Parker O-Ring #2-367	#
31	1	Piston O-Ring #2-338	#
32	1	Piston Wear Ring #W2-8000-750	#
33	1	TFER8000 Bronze w/Loader Ring	#
34	1	Square Ring - #4426	#



II. MAJOR COMPONENT DEFINITION (Continued...)

II-8. Engine Component Identification.

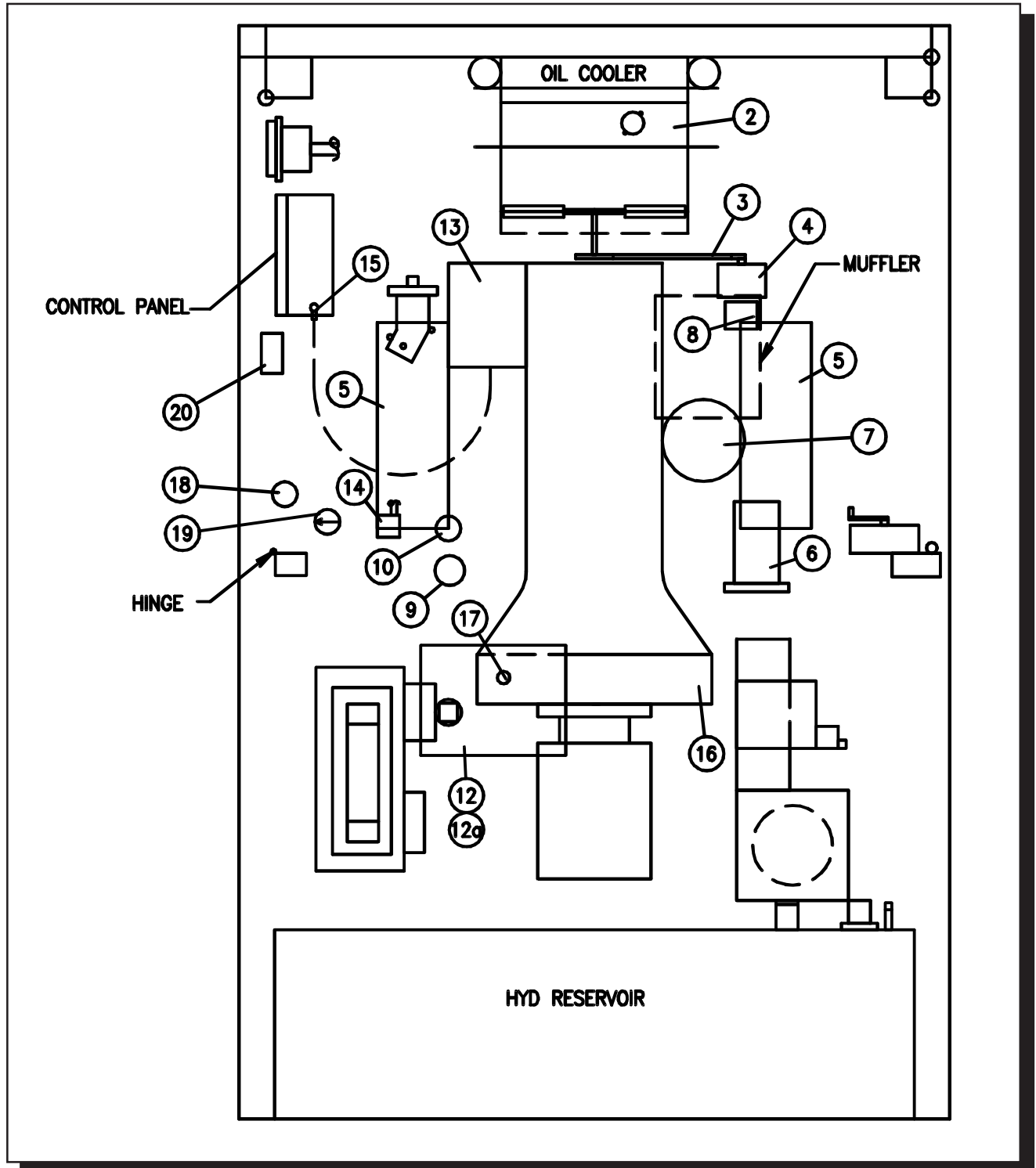
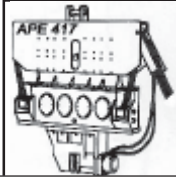

Figure 2-K1. Engine Component Identification.



II. MAJOR COMPONENT DEFINITION (Continued...)

II-8. Engine Component Identification (Continued...)

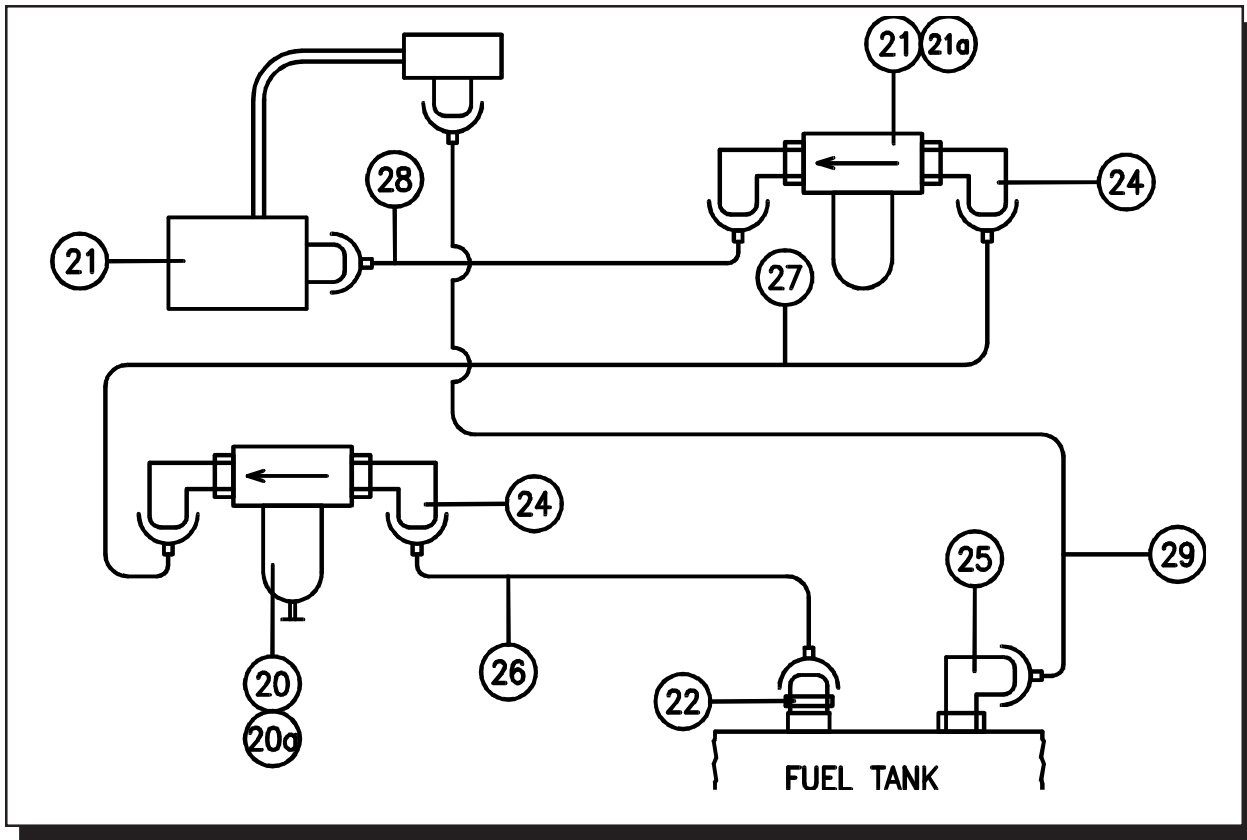
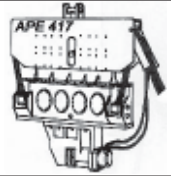

Figure 2-K2. Fuel Line Plumbing.



OPERATION / MAINTENANCE MANUAL

MODEL 417B VIBRATORY HAMMER WITH MODEL 260 POWER UNIT



7032 SOUTH 196th - KENT, WA 98032 - (253) 872-0141 / FAX (253) 872-8710

II. MAJOR COMPONENT DEFINITION (Continued...)

II-8. Engine Component Identification (Continued...).

Table 2-G. Engine Component Identification.

Item	Qty	Description	Manufacturer	Part Number
1	1	Diesel Engine	Cummins(240hp)	6CTA 8.3P
2	1	Radiator	Power Mark	10000135
3	1	Alternator Belt	Cummins	3911571
4	1	Alternator	Cummins	3920678
5	2	Battery	Interstate	4DVHD
6	1	Starter Motor	Cummins	3920329
7	1	Engine Oil Filter	Fleetguard	LF3000
8	1	Precharge Filter	Fleetguard	WF2071
9	1	Primary Fuel Filter	Fleetguard	FS1280
10	1	Secondary Fuel Filter	Fleetguard	FF5052
11	1	Dip Stick	Cummins	3905786
12	1	Engine Air Filter	Donaldson	EPG110119
12a	1	Element	Donaldson	P527484
13	1	Engine Governor	Cummins	_____
14	1	Governor Controller	Murphy	AT-67207 (24Vdc)
15	1	Manual Throttle	Instrument Sales	29V0096
16	1	Pump Drive	Hub City/Fed. Gear	751D
17	1	RPM Sensor	Isspro	R8935
18	1	Fuel Fill Cap	2" Pipe Cap	_____
19	1	Fuel Oil Level Gage	Rochester	8680-L9.5
20	1	Fuel Filter Head	FleetGuard	1 inch
20a	1	Filter Element	Fleetguard	FS1242
22	1	Straight Conn.	Brass	3/8" NPT to 1/4" Barb
23	1	Fuel Hose.	_____	1/4" ID x 14" Lg.
24	1	Fuel Hose	_____	1/4" ID x 24" Lg.
25	1	Fuel Hose	_____	1/4" ID x 30" Lg.
26	7	Hose Clamp	_____	1/4"
27	2	90 Deg. Hose Barb	Brass	3/8" NPT to 1/4" Barb
28	1	90 Deg. Hose Barb	Brass	1/4" NPT to 1/4" Barb
29	2	Bushing	Brass	1/4" x 1/2".
30	1	Hose Barb Union	Brass	1/4" x 1/4"
31	1	Hose Barb	Brass	1/4" NPT to 1/4" Barb

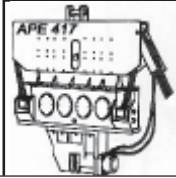

II. MAJOR COMPONENT DEFINITION (Continued...)

II-9. Major Hydraulic Component Identification.

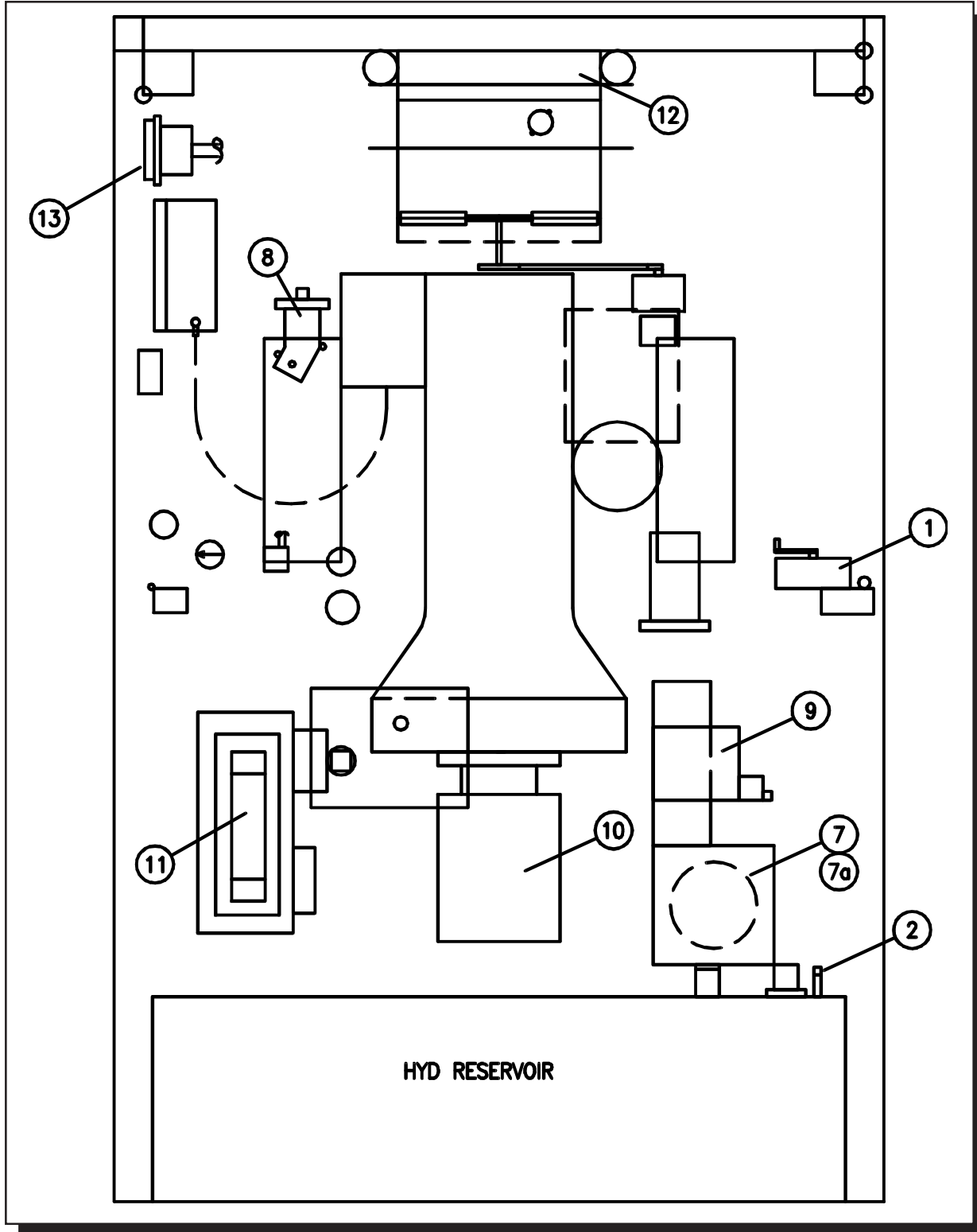

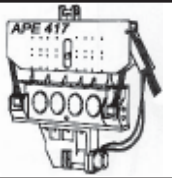

II. MAJOR COMPONENT DEFINITION (Continued...)

II-9. Major Hydraulic Component Identification (Continued...).

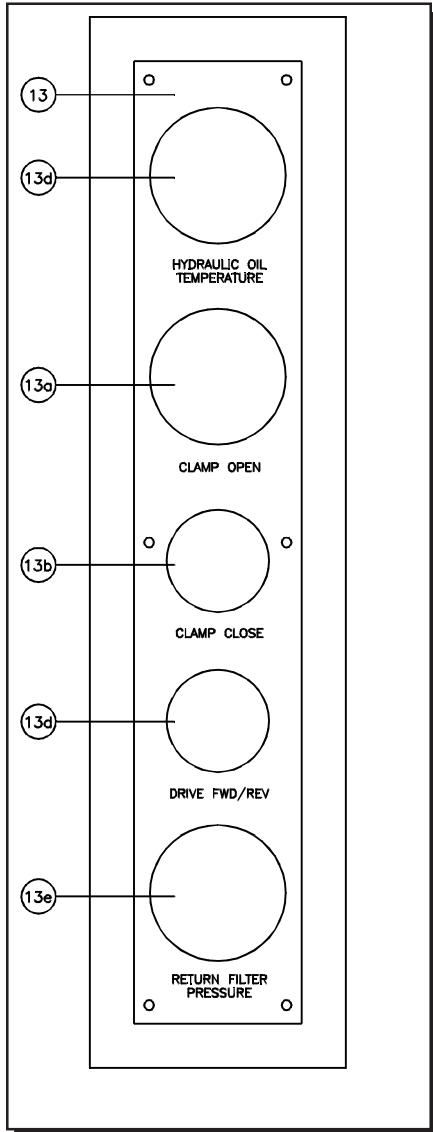

Figure 2-L2. Gage Assembly.

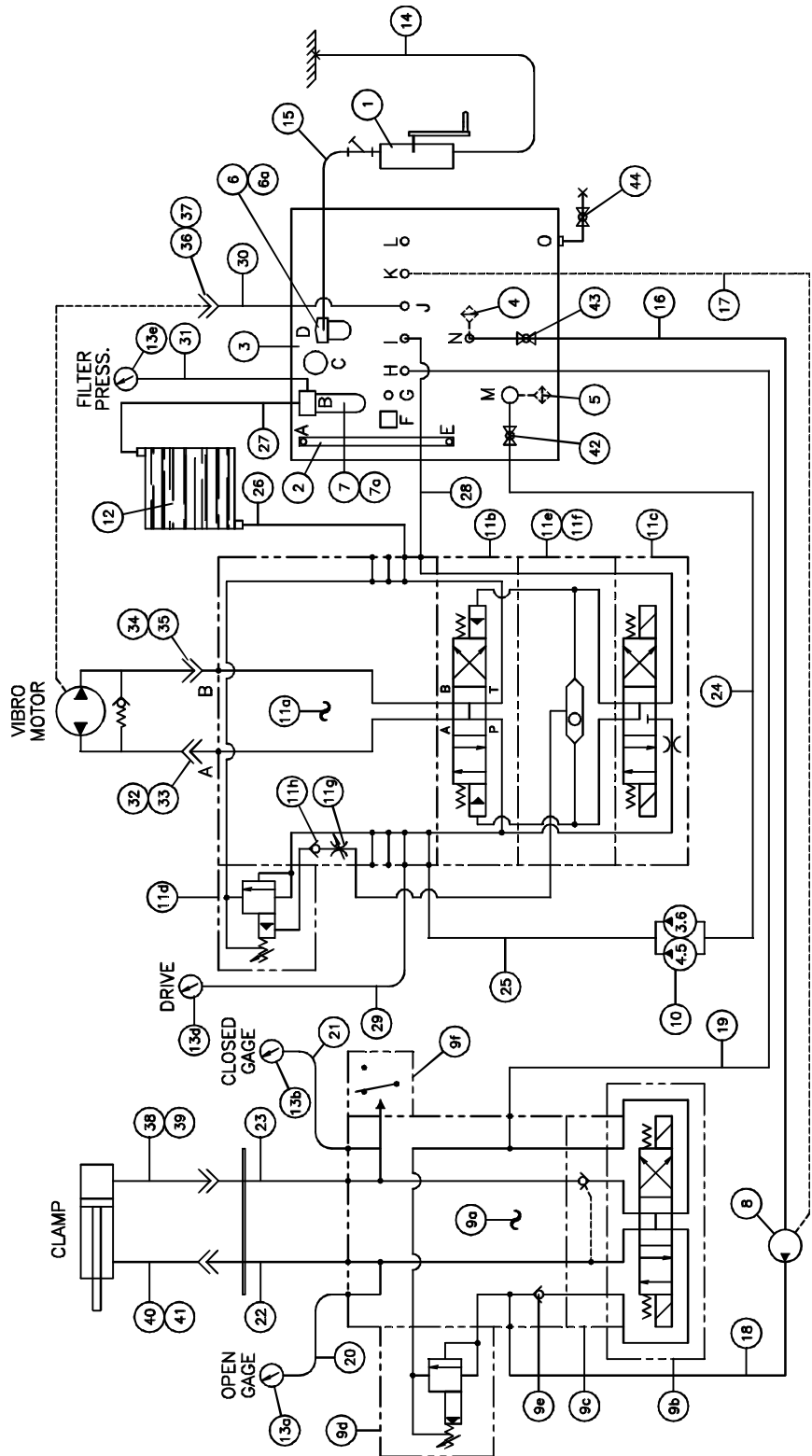
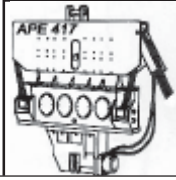

Figure 2-H3. Hydraulic Schematic Diagram.



OPERATION / MAINTENANCE MANUAL

MODEL 417 VIBRATORY HAMMER WITH MODEL 260 POWER UNIT



7032 SOUTH 196th - KENT, WA 98032 - (253) 872-0141 / FAX (253) 872-8710

II. MAJOR COMPONENT DEFINITION (Continued...)

II-9. Major Hydraulic Component Identification (Continued...).

Table 2-G. Engine Component Identification.

Item	Qty.	Description	Manufacturer	Part Number	APE PIN
1	1	Hand Pump	Blackmer	PA414	513010
2	1	Sight Gage	Lube Devices	G607-30-1-1/2"	523010
3	1	Air Breather	Lentz	BF16-1	513002
4	0	Suction Strainer			523013
5	0	Suction Strainer			523014
6	1	1" Fill Line Filter	Vickers	OR2P10	_____
6a	1	Filter Element	Vickers	573082	573082
7	1	2" Return Filter	Pall	HH7502B32DSSBPL	_____
7a	1	Filter Element	Pall	HC7500SKS8H	_____
8	1	Clamp Pump	Rexroth	AA2FM16/61W-NSC530	523021
9	1	Clamp Valve Assy.	Rexroth	HS-43-A37-2280-B-2	_____
9a	1	Clamp Manifold Block	Rexroth	AGA-6973-1D-0	_____
9b	1	Four Way Solenoid Valve	Rexroth	4WEH1D3X/CG24N9DK25L	_____
9c		Pilot Check	Rexroth	Z2S10B1-3X	_____
9d	1	Relief Valve	Rexroth	DBDH10P1X/400/12	_____
9e	1	Check Valve Cartridge	SUN	CXDA-XCN	_____
9f	1	8KPSI Pressure Switch	Oildyne	0E4-SBHS-8K	523037
10	1	Gear Pump(4.5 x 3.6 CID)	CSI	P465B178BIAB12-7-SPL- AB10-1	523021
11	1	Drive Valve Assembly	Rexroth	HS-43-A37-2279-B-4	_____
11a	1	Drive Manifold Block	Rexroth	AGA-6972-1-D-0	_____
11b	1	Four Way Valve	Rexroth	H4WEH25H60/6AGL4NEZ55L/B08	_____
11c	1	Four Way Pilot Valve	Rexroth	4WE6J51/AG24NZ55L/B08	_____
11d	1	Relief Valve	Rexroth	DB20-1-52/350X/12	_____
11e	2	Shuttle Valve	SUN	CSAA-5XN-GBS/S	_____
11f	1	Shuttle Valve Plate	SUN	991013	_____
11g	1	Cartridge Needle Valve	SUN	NFCC-LCN	_____
11h	1	Cartridge Check Valve	SUN	CXCD-XCN	_____
12	1	Heat Exchanger	TT	DH-626-1-1/L-82206	523017
13	1	Gage Assembly	APE	_____	_____
13a	1	Clamp Open Gage	NoShok	23-310-7500PSI	_____
13b	1	Clamp Close Gage	NoShok	23-310-7500PSI	_____
13c	1	Hyd Oil Temp Gage	Murphy	(25T-250-20) 10-70-3478	_____
13d	1	Drive Press Gage	NoShok	23-310-7500PSI	_____
13e	1	Return Filter Gage	NoShok	25-310-100PSI	_____
14	1	1.25" Hose x 96" Lg. (Swivel-Hose-Swivel)	Buckeye Imperial East.	Bellows-Flex EL-20-20-NJ Ends	_____
15	1	1" Hose x 33" Lg. (Swivel-Hose-Swivel)	_____	R4 HU-16-16-NJ Ends	_____
16	1	1" Hose x 55" Lg. (Swivel-Hose-Swivel)	_____	R1AT HU-16-16-NJ Ends	_____
17	1	.375" Hose x 58" Lg. (Swivel-Hose-Swivel)	_____	R2AT HU-6-6-NJ Ends	_____
18	1	.5" Hose x 86" Lg. (Swivel-Hose-Swivel)	_____	HTB HU-8-8-NJ Ends	_____



OPERATION / MAINTENANCE MANUAL

MODEL 417B VIBRATORY HAMMER WITH MODEL 260 POWER UNIT

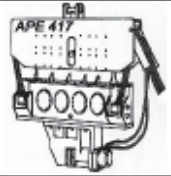

7032 SOUTH 196th - KENT, WA 98032 - (253) 872-0141 / FAX (253) 872-8710

II. MAJOR COMPONENT DEFINITION (Continued...)

II-9. Major Hydraulic Component Identification (Continued...).

Table 2-G. Engine Component Identification (Continued...).

Item	Qty.	Description	Manufacturer	Part Number	APE PIN
19	1	.75" Hose x 46"Lg. (Swivel-Hose-Swivel)	Imperial E.	R2AT HU-12-12-NJ Ends	_____
20	1	.25" Hose x 125"Lg (Swivel-Hose-Swivel)	Imperial E.	R2AT HU-4-4-NJ Ends	_____
21	1	.25" Hose x 130"Lg (Swivel-Hose-Swivel)	Imperial E.	R2AT HU-4-4-NJ Ends	_____
22	1	.5" Hose x 31"Lg. (Swivel-Hose-Swivel)	Imperial E.	HTB HU-8-8-NJ Ends	_____
23	1	.5" Hose x 34"Lg. (Swivel-Hose-Swivel)	Imperial E.	HTB HU-8-8-NJ Ends	_____
24	1	Suction Hose x 11" Lg (Blank Ends)	None	Suction	_____
25	1	1.25" Hose x 65"Lg (Swivel-Hose-Swivel)	Imperial E.	R13 JJ-20-20-NJ Ends	_____
26	1	1.25" Hose x 91"Lg. (Swivel-Hose-90 Deg.Swivel)	Imperial E.	R2AT HL-20-20-NJ End + HL-20-20-NJ 90 Deg End	_____
27	1	1.25" Hose x 76"Lg. (Swivel-Hose-Swivel)	Imperial E.	R2AT HL-20-20-NJ Ends	_____
28	1	.5 Hose x 36"Lg. (Swivel-Hose-Swivel)	Imperial E.	R1AT HU-8-8-NJ Ends	_____
29	1	.25" Hose x 135"Lg. (Swivel-Hose-Swivel)	Imperial E.	R2AT HU-4-4-NJ Ends	_____
30	1	.75" Hose x 23"Lg. (Swivel-Hose-Swivel)	Imperial E.	R2AT HU-12-12-NJ Ends	_____
31	1	.25" Hose x 96"Lg. (Swivel-Hose-Swivel)	Imperial E	R2AT HU-4-4-NJ Ends	_____
32	1	Male Quick Disconnect	APE	400303	400303
33	1	Dust Cap	APE	400703	400703
34	1	Female Quick Disconnect	APE	400301	400301
35	1	Dust Plug	APE	400704	400704
36	1	Fem Quick Disconnect	Aeroquip	5100-S5B	_____
37	1	Dust Plug	Aeroquip	5100-S9-12S	_____
38	1	Female Quick Disc	Safeway	S35-3	421024
39	1	Dust Plug	Safeway	S43-3	421027
40	1	Male Quick Disc	Safeway	S31-3	421025
41	1	Dust Cap	Safeway	S39-3	421026
42	1	2" Ball Valve(Welded)	Jomar	T-CS 1000-4B	_____
43	1	1" Ball Valve	Jomar	T-100	_____
44	1	1" Ball Valve	Jomar	T-100	_____

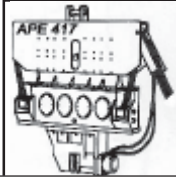

II. MAJOR COMPONENT DEFINITION (Continued...)

II-9. Major Hydraulic Component Identification (Continued...)

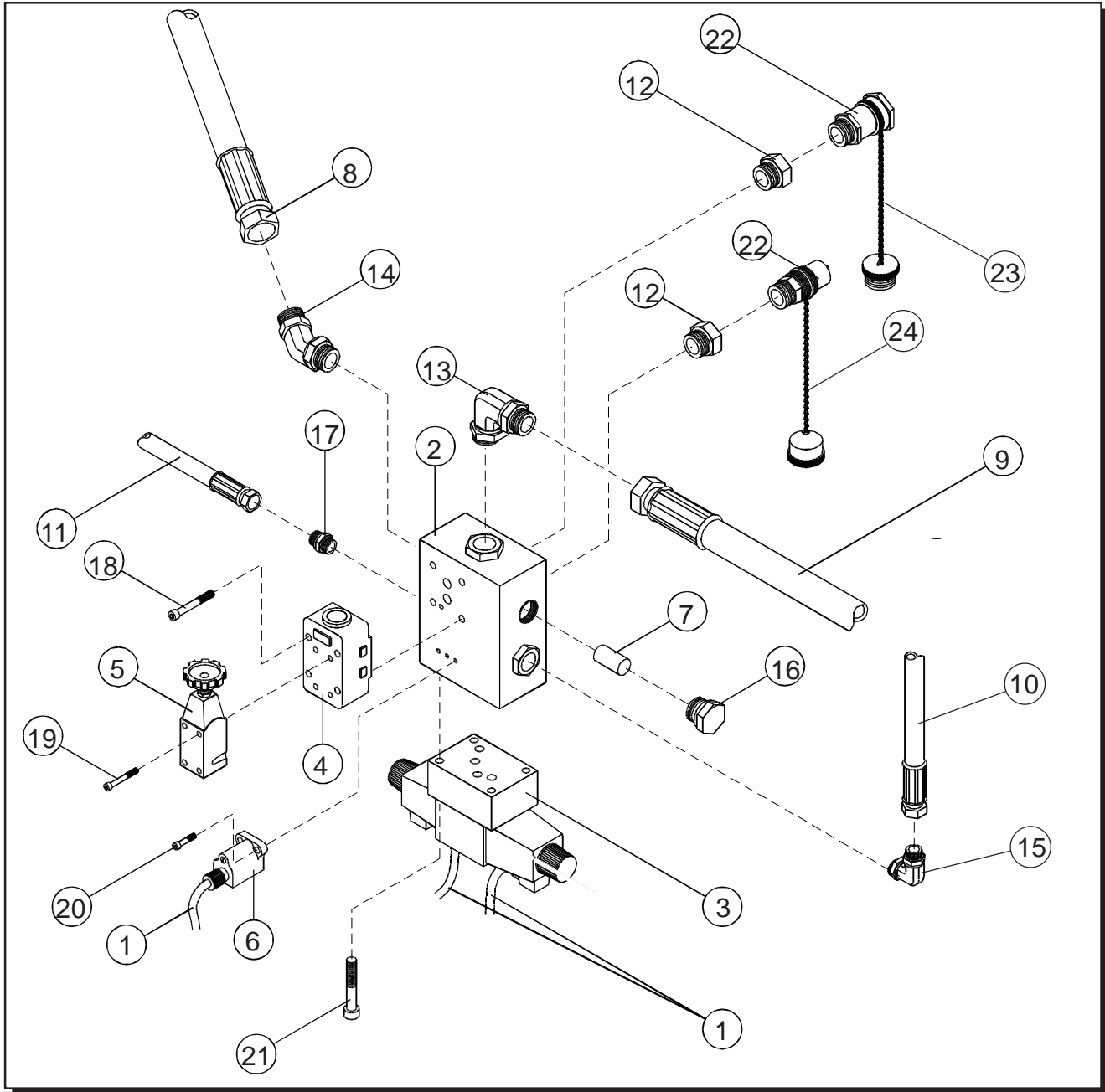
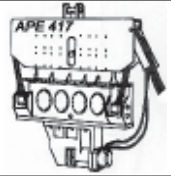

Figure 2-L4. Hydraulic Clamp Manifold Assembly.



OPERATION / MAINTENANCE MANUAL

MODEL 417B VIBRATORY HAMMER WITH MODEL 260 POWER UNIT



7032 SOUTH 196th - KENT, WA 98032 - (253) 872-0141 / FAX (253) 872-8710

II. MAJOR COMPONENT DEFINITION (Continued...)

II-9. Major Hydraulic Component Identification (Continued...).

Table 2-H1. Hydraulic Clamp Manifold Assembly.

Item	Qty.	Description	Manufacturer	Manuf. Part #	APE PIN
1.	3	Elect. Cable to Control Panel	—	—	—
2.	1	Clamp Manifold	—	9200030A	523002
3.	1	NG 25 Control Valve	Bosch	0-810-001-708	513017
4.	1	Relief Valve	Bosch	0-811-101-170	513018
5.	1	Pilot Valve (Part of Rel. Valve)	Bosch	0-811-101-170	513018
6.	1	Pressure Switch	Oildyne	0E4-SBHS-8K	700017
7.	1	Cartridge Check	Sun Hyd.	CXDA-XCN	513019
8.	1	Pressure Hose - Clamp Pump	—	—	—
9.	1	Hose, Clamp Manifold to Tank	—	—	—
10.	1	Hose Pressure Gauge	—	—	—
11.	1	Hose Pressure Gauge	—	—	—
12.	2	Fitting, NPT 1/2" Fem. to 3/8"	—	0201-8-6	—
13.	1	Fitting, 90 Deg - 12 O-Ring/JIC	Parker	12-12 V50X	—
14.	1	Fitting, 45 Deg. - 12 NPT/JIC	Parker	12-VTX	—
15.	2	Fitting, 90 Deg. - 4 NPT/JIC	Parker	4CTX	—
16.	1	Plug, 3/4" St. Thread O-ring	Parker	-12 P50N	—
17.	1	Fitting, 1/4"NPT/NPT	Parker	-4 FF	—
18.	4	Bolt, 3/8-16 x 3 1/4 SHCS	—	—	—
19.	4	Bolt, 10-24 x 1 1/2" SHCS	—	—	—
20.	2	Bolt, 10-24 x 1 SHCS	—	—	—
21.	4	Bolt, 1/4-20 x 3 1/2 SHCS	—	—	—
22.	1	Pair Quick Disconnects	Safeway	S-30-3	421023
23.	1	Dust Plug	Safeway	S-34-3	421027
24.	1	Dust Cap	Safeway	S-34-9	421026
25.	3	2" Female 90 Deg. P.T.	—	—	—

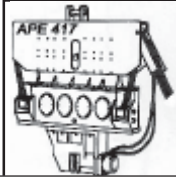

II. MAJOR COMPONENT DEFINITION (Continued...)

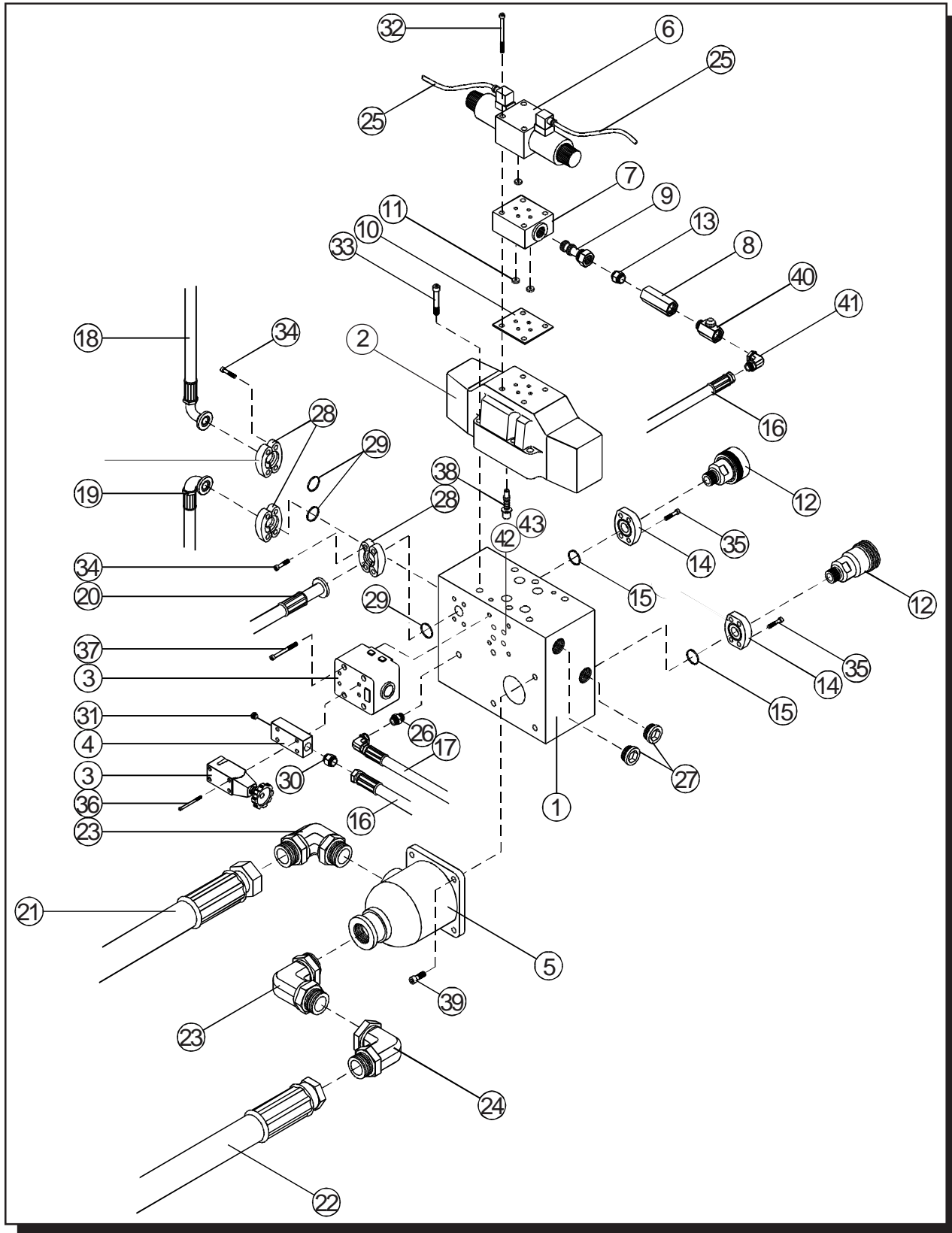
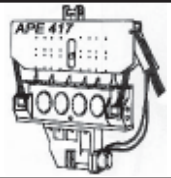

Figure 2-L5. Hydraulic Drive Manifold Assembly.



OPERATION / MAINTENANCE MANUAL

MODEL 417B VIBRATORY HAMMER WITH MODEL 260 POWER UNIT



7032 SOUTH 196th - KENT, WA 98032 - (253) 872-0141 / FAX (253) 872-8710

II. MAJOR COMPONENT DEFINITION (Continued...)

II-9. Major Hydraulic Component Identification (Continued...).

Table 2-H2. Hydraulic Drive Manifold Assembly.

Item	Qty.	Description	Manufacturer	Manuf. Part #	APE PIN
1.	1	Drive Manifold	—	9209012B	513028
2.	1	Directional Valve	Bosch	9-000-010-209	—
3.	1	Relief Valve	—	0-810-010-170	—
4.	1	Tap Plate	Rucker	—	—
5.	1	Amot Valve	Amot	2BOCTL2001	513024
6.	1	Directional Valve Pilot	Bosch	9-000-010-209	700017
7.	1	Shuttle Body	Sun Hyd..	GBS-S	513030
8.	1	Bleed off Check	—	CPIFF-2P-65	—
9.	1	Shuttle Cartridge	Sun Hyd.	CSAA-EXN	513030
10.	1	Adapter Plate	Rucker	—	—
11.	2	Pilot Orifice Restrictor	—	CPIFF-2P-65	—
12.	1	Quick Disconnects (Pair M/F)	APE	400301	400303
13.	1	Fitting, 1/4" JIC/St. Thd. O-Ring	Parker	-4-4 F50X	—
14.	2	Anchor Flange	Anchor	W44-24-24U	400100
15.	2	O-Ring 1 1/4" x 1/8" Dia.	Parker	2-218 N674-70	—
16.	1	Pilot Hose, Drive Manifold	—	—	—
17.	1	Pressure Gauge Line	—	—	—
18.	1	L.R. Drive Pump Hose	—	—	—
19.	1	L.L. Drive Pump Hose	—	—	—
20.	1	Mid Drive Pump Hose	—	—	—
21.	1	Return Filter to Amot Valve Hose	—	—	—
22.	1	Amot Valve to Oil Cooler Inlet Hose	—	—	—
23.	2	2" 90 Deg. JIC/NPT	Parker	-32 CTX	—
24.	1	2" JIC/Fem. Swivel	Parker	-32 FTX	—
25.	2	Elect. Cable to Control Panel	—	—	—
26.	1	Fitting, 1/4"NPT/1/4" JIC	Parker	-4FTX	631017
27.	1	Straight O-Ring	Parker	2-225	113020
28.	—	Code 62 Split Flanges	Parker	-16 SFXO	113010
29.	3	Flange O-Ring	Parker	2-225	113020
30.	1	Adapter - 1/4 Straight Thread/JIC	Parker	-4-4 50X	—
31.					
32.	4	Bolt, M 5.8 x 60 SHCS	—	—	—
33.	6	Bolt, 1/2-13 x 2 1/2 SHCS w/Hi-Collar	—	—	—
34.	12	Bolt, SHCS	—	—	—
35.	8	Bolt, 5/8-11 x 2 3/4 SHCS	—	—	—
36.	4	Bolt, M 5.8 x 75 SHCS	—	—	—
37.	4	Bolt, 3/8UNC x 3 1/4 SHCS	—	—	—
38.	1	Back Pressure Check	Bosch	1-817-419-038	513031
39.	4	Bolt, 3/8UNC x 1 1/4 Hex Hd. w/LW	—	—	—
40.	1	Snubber (Needle) Valve	Sun Hyd.	NSAB-KXV-BA	513026
41.	2	Fitting, 90 Deg. 4 NPT/JIC	Parker	4 CTX	—
42.	2	O-Ring, Valve (Metric)	—	2.0x10.0	—
43.	2	O-Ring, Valve (Metric)	—	3.0x28.0	—

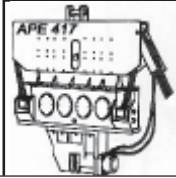

II. MAJOR COMPONENT DEFINITION (Continued...)

II-10. Control Panel and Parts.

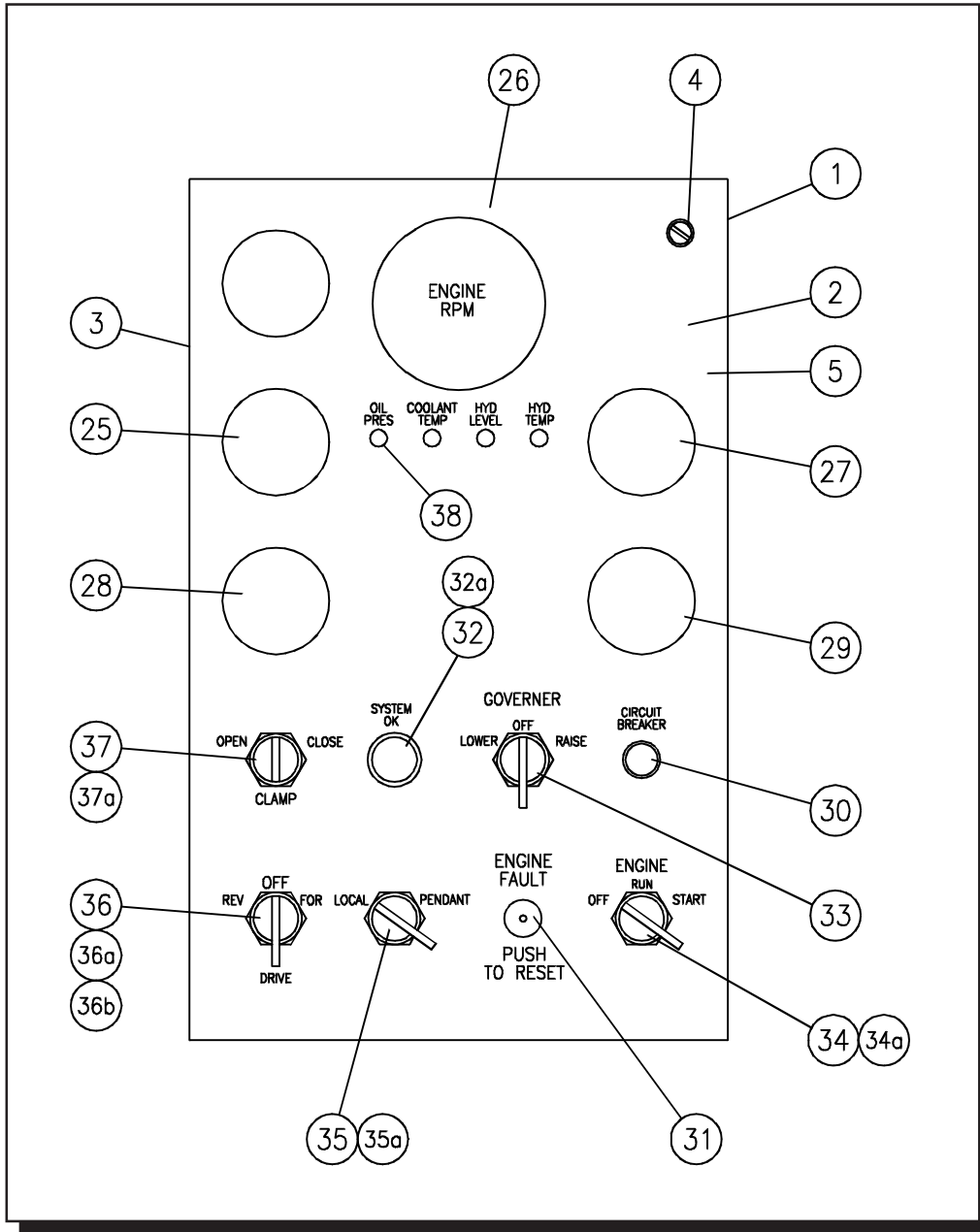
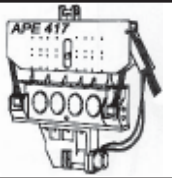

Figure 2-M1. Control Panel Front View.



II. MAJOR COMPONENT DEFINITION (Continued...)

II-10. Control Panel and Parts (Continued...).

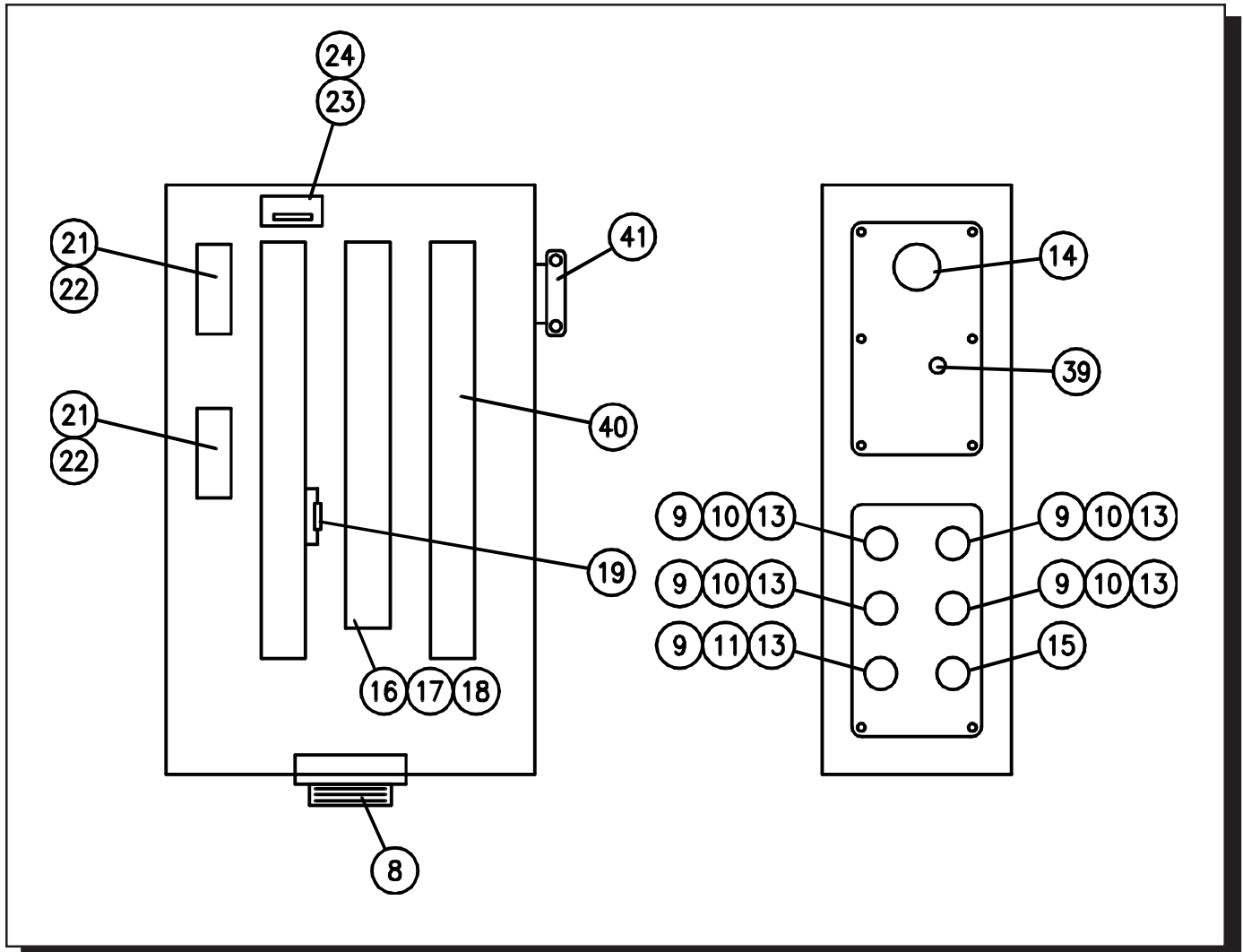
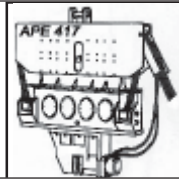

Figure 2-M2. Control Panel Internal View.



OPERATION / MAINTENANCE MANUAL

MODEL 417 VIBRATORY HAMMER WITH MODEL 260 POWER UNIT



7032 SOUTH 196th - KENT, WA 98032 - (253) 872-0141 / FAX (253) 872-8710

II. MAJOR COMPONENT DEFINITION (Continued...)

II-10. Control Panel and Parts - Table 2-I.

Item	Qty.	Description	Manufacturer	Manuf. Part #	APE PIN
1	1	Enclosure	Rittal	KL1537	_____
2	1	Enclosure Cover	Rittal	KL1569	_____
3	1	Cover Hinge	Rittal	KL1592	_____
4	2	Quick Fastener	Rittal	KL1593	_____
5	1	Panel Face Legend Plate	AAA	_____	_____
6	2	Shock Mount Feet	Vibration Elimination	T22-3	_____
7	4	Shock Mount Legs	Vibration Elimination	4DB	_____
8	1	Female Rec. (12 Pin)	Amphenol	MS3102A2B-18P	_____
9	5	Male Rec. (3 Pin)	Turck (Cascade)	RSF-35-1M	_____
10	4	Fem. Yellow Cord	Turck (Cascade)	RKM35-4M	_____
11	1	Double End Yellow Cord	Turck (Cascade)	WYMRKM364M	_____
12	1	Fem. Rec. (3 Pin)	Turck (Cascade)	RXF-36-1M	_____
13	5	1/2" Cord Connector	Hubble	SHC-1023-CR	_____
14	1	1" Non Metallic Connector	Thomas & Betts	3304	_____
15	1	1/8" Bulkhead Connector	Hydraline	_____	_____
16	36	Terminal Blocks	Marathon	6H38-TSKK-C	_____
17	1	Term. Block End Sect.	Marathon	6H38-E-C	_____
18	2	Term. Block End Clips	Marathon	MC	_____
19	15	Diode	I/R	6056	_____
20	1	Diode	I/R	1N4007	_____
21	2	2 Pole Relay Base	Idec	SH2B-05	_____
22	2	2 Pole Relay	Idec	RH2BU-DC24V	_____
23	1	Hourmeter (Drive)	_____	85094-12	_____
24	1	Hourmeter Support Bkt.	_____	23944	_____
25	1	Hourmeter (Engine)	Datcon	56458-10	_____
26	1	Engine Tachometer	Dynalco	SPD108-10000	_____
27	1	Ammeter	Datcon	06354-01	_____
28	1	Oil Pressure Gage	Murphy(20P-100)	10-70-3115	_____
29	1	Warer Temp Gage	Murphy(20T-250-10)	10-70-2045	_____
30	1	10 Amp Circuit Breaker	_____	W58-XC4C12A-10	_____
31	1	Engine Fault Switch	Murphy	117PH	_____
32	1	System OK Light	Cutler-Hammer	10250T206N/TC2N	_____
32a	1	Syst OK Light Bulb	General Electric	757	_____
33	1	Gov. Control Sw. Operator	Cutler-Hammer	10250T3043	_____
33a	1	Contact Block (NO + NO)	Cutler-Hammer	T2	_____
34	1	Eng. Control Sw. Operator	Cutler-Hammer	10250T3053	_____
34a	1	Contact Block (NO + NC)	Cutler-Hammer	T1	_____
35	1	Local/Pendant Sw. Oper.	Cutler-Hammer	10250T3011	_____
35a	1	Contact Block (2NO+2NC)	Cutler-Hammer	T44	_____
36	1	Drive Switch Operator	Cutler-Hammer	10250T3023	_____
36a	1	Contact Block (NO + NO)	Cutler-Hammer	T2	_____
36b	1	Contact Block (NC + NC)	Cutler-Hammer	T3	_____
37	1	Clamp Switch (Lighted)	Allen Bradley	800T24JG4KB7AX	_____
37a	1	Light Bulb	Sylvania	85	_____
38	4	L.E.D. Lights	Idec	AP8M222R	_____
39	1	Gromet	_____	_____	_____
40	1	Wireway	_____	1 1/2" x 1 1/2"	_____



OPERATION / MAINTENANCE MANUAL

MODEL 417B VIBRATORY HAMMER WITH MODEL 260 POWER UNIT

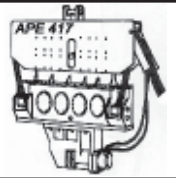

7032 SOUTH 196th - KENT, WA 98032 - (253) 872-0141 / FAX (253) 872-8710





OPERATION / MAINTENANCE MANUAL

MODEL 417 VIBRATORY HAMMER WITH MODEL 260 POWER UNIT

7032 SOUTH 196th - KENT, WA 98032 - (253) 872-0141 / FAX (253) 872-8710

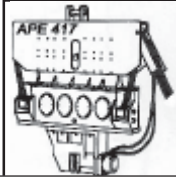

III. LOADING AND UNLOADING

III-1. Model 100 Vibratory Hammer

The APE 417 vibrator is normally shipped laying flat on the trailer deck and the hose bundle is coiled on top. Lift the vibrator by rigging one line to the lifting pin and one line around the clamp attachment lifting the vibro and hose bundle as one load. Avoid smashing hydraulic lines. Vibro should be loaded with hydraulic motor down facing the deck and breather valves facing the sky. Before the truck has left, carefully inspect the machine and hoses for any missing equipment or sign of damage that may have occurred during shipment or unloading.

III-2. Model 260 Power Unit

The Power Unit is always loaded with the oil cooler facing to the rear of the truck to prevent damage to the cooler and the radiator from flying objects. The Power Unit is usually held to the truck by wrapping a chain around both ends of the fuel tank base and the truck bed. After loading the Power Unit, tape the exhaust rain cap shut to prevent rain water from getting inside. If quick disconnects do not have safety cables then store them under the panel in the storage box rather than risk the possibility of the caps and plugs coming loose and falling off into traffic. Make sure all doors are fully closed. Tighten fuel cap to prevent diesel fuel from washing out the fill spout.

III-3. What to do if damaged during shipment

In the event of damage, notify the trucking agent at once. Note all damage on the bill of lading. Fax the information as soon as possible; any delay may make it impossible to find the responsible party.



OPERATION / MAINTENANCE MANUAL

MODEL 417B VIBRATORY HAMMER WITH MODEL 260 POWER UNIT

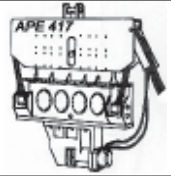

7032 SOUTH 196th - KENT, WA 98032 - (253) 872-0141 / FAX (253) 872-8710

IV. PREPARATION AND OPERATION

IV-1. Rigging of Vibratory Hammer

A steel wire rope sling must be connected to the lifting bail located on top of the vibro. The required strength of this sling depends on the capacity of the crane and the work to be carried out. A safety factor of six is recommended. Several turns of a smaller diameter cable will result in a longer lasting sling than one larger diameter cable. When making a sling, avoid using cheap cable clamps. Check the clamps daily.

IV-2. Installing the Clamp Attachment

The Vibro is fitted with a standard sheet clamp at the factory. However, several types of clamps are used on APE vibros to fit many different types of piles. A step by step procedure is provided as follows:

- 1.) Clean all drilled and tapped threads on the bottom surface of the gearbox. Use a 1 1/2"UNC tap to clean any rusted threads and blow out any remaining fragments with compressed air. If there is a cutting torch on the jobsite then use the oxygen setting to blast the threads clean. Hold a rag over the tapped hole to prevent flying dirt from blasting into your eyes.
- 2.) Clean the machined bottom surface of the gearbox and prepare to mount the clamp. If the clamp bolts should ever break, check the machined surface with a straight edge to make sure it is true and flat.
- 3.) Clean the machined surface of clamp. Eye-ball the entire surface for damage. Make sure the surface is flat and void of all dirt.
- 4.) Start by getting the center bolt in first and work outwards. Do not tighten bolts until you have all of the bolts started.
- 5.) Tighten bolts using a six-foot cheater pipe. If you do not have a cheater pipe then use a sledge hammer.
- 6.) Go around all bolts at least three times making sure they are tight.
- 7.) After vibrating the first pile, check the bolts again.
- 8.) If one bolt breaks, replace them all since they may be weak or cracked.
- 9.) Never operate the vibro with missing clamp bolts.

WARNING: Do not use grade five bolts. All bolts should be allen head cap screw bolts. If one bolt breaks then the others are damaged and must be replaced. Never drive piles if one bolt is broken. Bolts break only because they were not tight and the crew neglected to check them. A good operator insists that every bolt is checked twice daily.

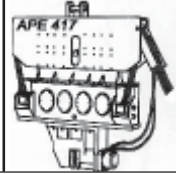

IV. PREPARATION AND OPERATION (Continued...)

IV-3. Plumbing the Vibro Hoses to the Power Unit

There are five hoses leading from the vibro that must be connected to the power unit to begin operation (Please see section III-2. Hose Identification on [page 2-3]). There are two big hoses, two little hoses and one middle sized hose. The hoses attach to the power unit by screwing the quick disconnect couplers onto the proper couplers of the power unit. The couplers on the power unit are mated with the couplers on the vibro so there is no chance of putting them on backwards. Please take the following steps when installing the couplers:

WARNING: TURN THE POWER UNIT OFF BEFORE INSTALLING COUPLERS

- 1.) Turn the power unit OFF.
- 2.) Clean all couplers with a can of ether if available. A clean dry cloth will also work but will require extreme care. Fittings must be spotless clean.
- 3.) Install couplers by screwing them onto their respective counterparts. Try to avoid cross-threading and maintain a straight line. Jerk the hose back and forth while turning coupler to aid installation effort. **Push hard to get the big coupler threads started.**
- 4.) Make sure fittings are tight. If they are properly cleaned they should run up tight with just a firm hand grip. However, they should be double checked with a chain wrench.
- 5.) Avoid over-tightening.
- 6.) If near salt water, spray with a light oil to prevent oxidation.
- 7.) Position the Power Unit so that vibrator has enough hose to reach the work. Avoid pulling too hard on hoses. Most hose failures are caused by pulling hoses off couplers.

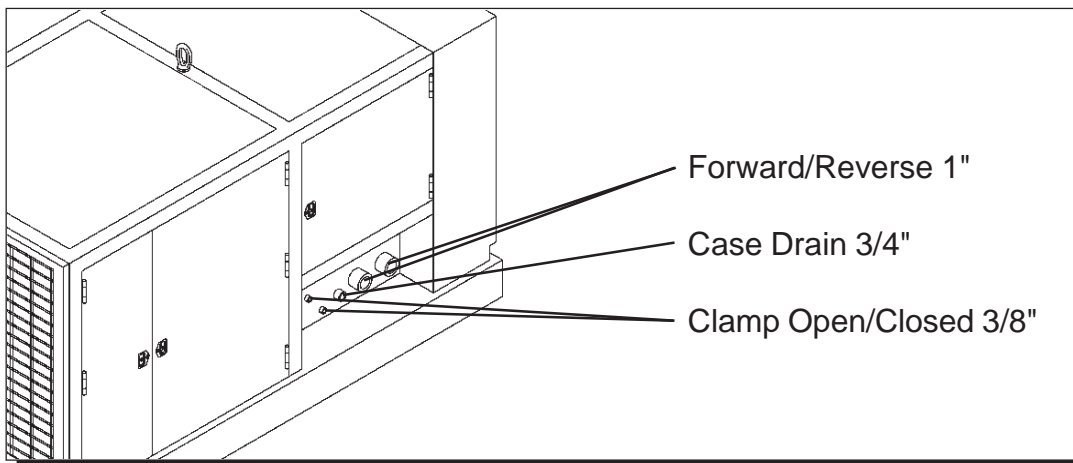
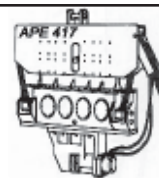

Figure 4-A. Power Unit Coupler Layout



IV. PREPARATION AND OPERATION (Continued...)

IV-4. Filling Vibrator Pressure Hose

The vibrator is shipped with the hoses filled with oil. However, if the unit has been sitting for a long period of time or if a damaged hose has been replaced with a new one, then the hoses must be filled. Hook up all the hoses to the power unit (see Section IV-3 on [page 4-2] and Figure 4-A.). Start the power unit and let it run for ten minutes before running the vibro. The hoses will fill up by themselves in ten minutes even if the vibro is not in the vibrate mode.

IV-5. Bleeding the Clamp Attachment Hydraulic Hoses

If the opening and closing of the jaws seems spongy or slow, it may be a result of air in the clamp hoses. Normally there is no need to worry about bleeding the clamp lines because the unit is shipped fully tested. However, should the vibro sit for a long period of time, if a new attachment is being installed or if a damaged clamp hose has been replaced, then the system may require bleeding to remove unwanted air in the system. To bleed the clamp system, follow these steps:

- 1.) Shut Power Unit OFF.
- 2.) Make sure the clamp line quick dis-connects are coupled to the power unit.
- 3.) Start the power unit engine and run at 1500 rpm. Give the engine time to warm up.
- 4.) Loosen the clamp lines at the hydraulic cylinder by backing the fittings off just a little.
- 5.) Turn the clamp switch on the power unit control pendant to "CLOSE" and wait for oil to flow from the fittings. WATCH FOR AIR BUBBLES. When air bubbles have stopped then quickly re-tighten the fittings.
- 6.) Repeat the same procedure for "OPEN" side.
- 7.) Operate the jaws. If they are still a bit spongy then repeat bleeding steps once more.

WARNING: DO NOT BLEED SYSTEM AT FULL ENGINE THROTTLE BECAUSE TOO MUCH OIL WILL FLOW FROM THE HOSES AND COULD CAUSE INJURY.

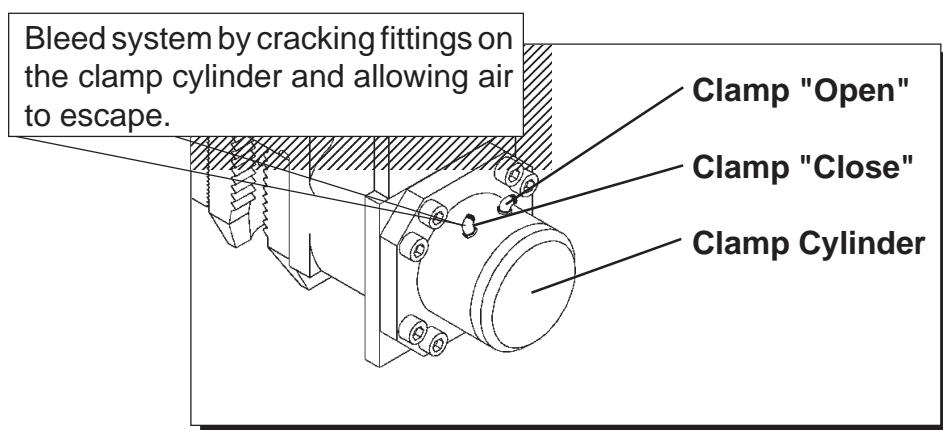
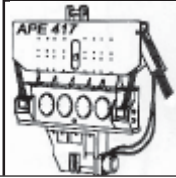

Figure 4-B. Bleeding Clamp Attachment



OPERATION / MAINTENANCE MANUAL

MODEL 417 VIBRATORY HAMMER WITH MODEL 260 POWER UNIT



7032 SOUTH 196th - KENT, WA 98032 - (253) 872-0141 / FAX (253) 872-8710

IV. PREPARATION AND OPERATION (Continued...)

IV-6. Precautions and Rules for Operation

The following is a list of precautions, suggestions and rules that are intended to help promote the safe and productive use of the APE Model 100 Vibratory Hammer.

- 1.) Follow the Daily Maintenance Required Prior to Operation, [Section V-1.] [page 5-1].
- 2.) Read and follow the Safety Precautions, [page v].
- 3.) Follow the start-up procedures listed in the manual for the power unit being used.
- 4.) Start with piles in good condition.
- 5.) Put all teeth in pile.
- 6.) Drive in steps eight feet or less.
- 7.) Keep sheets plumb.
- 8.) Come up to speed before doing work.
- 9.) No dancing. Avoid de-intensification.
- 10.) Drive past obstacles and then go back.
- 11.) Backhoe on site to remove obstacles.
- 12.) Lead with the ball.
- 13.) Probe the pile if it appears stuck.
- 14.) Keep piles plumb or down the road you go.
- 15.) Never rush the sheet pile foreman.
- 16.) Slow and plumb and the job will get done.
- 17.) Melted inner locks - piles out of plumb.
- 18.) Never stand under pile hammers.
- 19.) Low clamp pressure means jaw failures.
- 20.) Wait for vibro to get to full speed then pull.
- 21.) Don't over excavate - lower the ring.
- 22.) Look at the jaws during driving.
- 23.) Beware of cracked or broken sheets.
- 24.) In sandy soils drive faster.
- 25.) In clay amplitude is everything.
- 26.) Low drive pressure means easy work.
- 27.) High pressure means friction on piles.
- 28.) Over 4500 psi means get a bigger hammer.
- 29.) No amplitude means get a bigger hammer.
- 30.) Caissons need heavy wall to avoid flex.
- 31.) Check clamp bolts each morning.
- 32.) Read the manual - know your machine.
- 33.) Attach whip line to pile when pulling.
- 34.) Know your line pull.
- 35.) Extract straight - look at boom and cable.
- 36.) Give boom stops some room.
- 37.) Stalled engine means dirty fuel filters.



OPERATION / MAINTENANCE MANUAL

MODEL 417B VIBRATORY HAMMER WITH MODEL 260 POWER UNIT

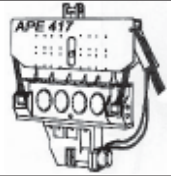

7032 SOUTH 196th - KENT, WA 98032 - (253) 872-0141 / FAX (253) 872-8710

IV. PREPARATION AND OPERATION (Continued...)

IV-7. Relief Valve Settings Prior to Operation - Model 240

1. Do not hook up quick disconnects. Start engine and bring to full rpm.
2. Check Clamp relief valve setting by turning clamp switch to "open" and holding it there while you read the clamp "open" gauge on the panel. The gauge should read 3300 psi. If it is not coming up to pressure then set the relief valve (FACTORY AUTHORIZED PERSONNEL ONLY) by loosening the lock nut and turning the knob in slowly until the proper pressure is reached. Turn in to increase pressure and out to decrease pressure. Lock the locknut and re-check the pressure to make sure that you did not move the setting while you were tightening the lock nut. When you turn the clamp switch to "open" and hold it, a small light on the solenoid comes on to show that there is power to the solenoid. The solenoid light should go off when you turn it to the "Off" position.
3. Check the clamp pressure switch setting. Turn the clamp to "close" and see if the green light comes on indicating proper clamp pressure. If it does then everything is fine. Clamp pressure should read 3000 psi and light on pendant or panel should be lit. To set the pressure switch, turn the set screw out using a screwdriver. Turn it out a few turns counter clockwise. Turn clamp switch to "open" for a second. Make sure the clamp open gauge reads 3300 psi. If it does not, then go back to step 2 and set the clamp relief valve first. Knowing that your clamp relief valve is set to 3300 psi, turn the clamp switch to "closed." Green light should be on and clamp pressure should be very low or notreading at all. If green light is on then slowly turn the pressure switch screw clockwise with a screw driver until the pressure is 3000 psi or 300 psi below the clamp relief valve setting. Always set the clamp pressure switch 300 psi below the clamp relief valve setting or the light will never come on. We do not want the clamp pump to pump oil over the relief valve because this will cause heat and take away 25 horsepower from the engine. Call the factory if you have any questions. (800) 248-8498

IV-8. Shut-down Procedures

The following procedures explain what to do with the power unit to correctly shut down the APE Model 50 Vibratory Hammer.

- 1.) Stop the vibrator. (Refer to the power unit operating manual .)
- 2.) Allow the diesel engine to run for five minutes at 1000 engine rpms.
- 3.) Reduce engine speed to low idle for about 60 seconds.
- 4.) Shut engine off by turning off the main power switch.

WARNING: Do not shut the power unit engine down while the vibrator is clamped onto a pile. The clamp check valve will slowly bleed off if there is any leakage in the hose lines or worn clamp seals in the cylinder that moves the jaw open or closed.

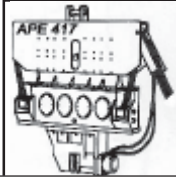

IV. PREPARATION AND OPERATION (Continued...)

IV-9. Operation of the Remote Control Pendant

1. All functions of the vibro can be controlled by the hand held pendant. It is the choice of the crew as to where best to locate the pendant. Some prefer to give it to the crane operator so he can control all functions. Others prefer to give it to one of the ground crew so that he can position himself close to the work at hand. A 50 foot cord is provided as standard equipment. If this is not long enough, additional 50 foot sections can be added. Should the pendant become damaged, all functions can be manually operated. See Section VII-3, Page 7-8 in this manual for more details on operation. See Section VII-3A, Page 7-9 of this manual for wiring diagram and pendant components.

IV-10. Normal steps to operate vibrator:

1. Position vibro on pile.
2. Turn clamp switch to Closed position and wait for light in the Clamp switch to turn on.
3. Turn the Drive switch to the Forward position to begin vibrating the pile.
4. To drive, lower crane line as vibro vibrates pile.
5. To extract, pull up on vibro while vibrating.
6. See "Precautions and Rules for Operation" in this manual for more detailed operations on driving and extracting piles.
7. To stop the vibro turn the Forward switch to off.
8. To release clamp, turn and hold the Clamp switch to the OPEN position until the clamp is open.

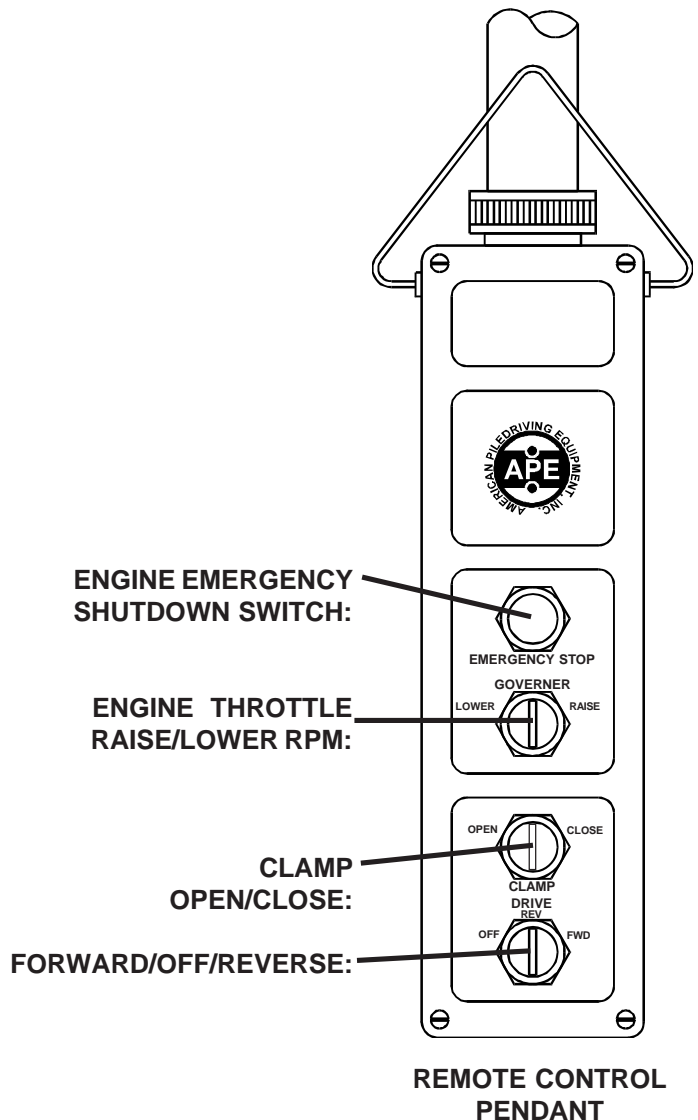

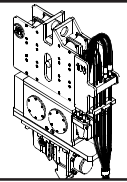

V. MAINTENANCE

V-1. Daily Maintenance Required Prior to Operation

- 1.) Visually inspect the entire vibro for loose nuts or bolts. Put a wrench on the clamp bolts and check them for tightness.
- 2.) Grease the Jaw Plunger on the clamp housing.
- 3.) Check the oil level in the vibrator. Hang vibro from crane and look at sight gauge. Make sure the oil is half way up gauge. If you cannot read it then you can't run the vibro. Remove the gauge and clean it by spraying a shot of starting fluid at it. **YOU MUST KNOW THE LEVEL!**

IF THE OIL LOOKS BLACK OR MILKY THEN DRAIN THE GEARCASE AND ADD NEW HYDRAULIC OIL.

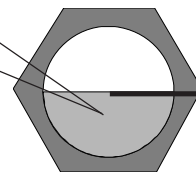

**Oil Level
Mobil Gear 626 or equal.**

Sight Gauge

- 4.) If the oil is milky or black then change it. **Change the oil every 75 hours regardless.**
- 5.) Check the fluid level in the power unit hydraulic tank.
- 6.) Look at all the hoses. Check for cuts or other damage that might cause an oil leak.
- 7.) Check the rubbers in the suppressor housing. Look for cracks.
- 8.) Perform all start up checks as per the "start-up procedures" in the Power Unit manual.

V-2. Checklist Once Power Unit Engine Is Started

- 1.) Check all hydraulic hoses for leaks. Make sure they hang free with no kinks.
- 2.) Check inside the Power Unit. Look at all hoses and valves, check for leaks.
- 3.) Check filter indicator with engine running at full rpm. Replace if necessary.
- 4.) Check wire rope sling and make sure it is in excellent condition.
- 5.) Check jaws for wear. Replace if necessary.
- 6.) Close jaws, make sure clamp light comes on.



OPERATION / MAINTENANCE MANUAL

MODEL 100 VIBRATORY HAMMER WITH MODEL 260 POWER UNIT

7032 SOUTH 196th - KENT, WA 98032 - (253) 872-0141 / FAX (253) 872-8710

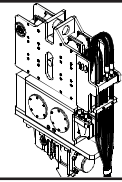

V. MAINTENANCE (Continued...)

V-3. Maintenance and Adjustments (75 Hours)

Change the oil in vibrator gearbox. Remove the drain plug from bottom of gearbox and drain the oil into a bucket. Check oil for any metal shavings. Replace oil in gearbox by adding 1.5 gallons of standard weight oil. Mobil Gear 626 or equivalent.

Clean the gearbox breathers each time the oil is changed. Replace the breathers if necessary.

V-4. Maintenance and Adjustments (Eccentric Bearings)

1.) Model 100 - The Eccentric Bearings should be checked and/or replaced after every 5000 hours of operation.

V-5. Maintenance and Adjustments in Severe Conditions

When average temperature is above (80 deg. F) or below (-1 deg. F) reduce servicing intervals to one half of those specified above.

When operating in the presence of dust or sand, reduce servicing intervals to one-third of those specified.

During stand-by or inactive periods, the servicing intervals may be reduced to one-half. The unit should be run every 30 days or less to keep internal parts lubricated.

V-6A. Lubrication - Vibratory Gearbox

The Gearbox oil should be changed weekly or when black or milky. Mobil Gear 626 or equal is the preferred oil. Just ask your oil supplier for an equivalent type of oil. The gearbox requires 1.5 gallons of oil.

V-6B. Lubrication - Clamp Attachment

The Clamp Attachment hydraulic oil must be checked and changed on a regular basis. The Clamp Cylinder Plunger should be checked for rust and debris. Lubricate the plunger on a regular basis using the grease zert on the side of the clamp housing.



OPERATION / MAINTENANCE MANUAL

MODEL 100 VIBRATORY HAMMER WITH MODEL 260 POWER UNIT

7032 SOUTH 196th - KENT, WA 98032 - (253) 872-0141 / FAX (253) 872-8710

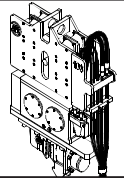

V. MAINTENANCE (Continued...)

V-7A. Power Unit - Filters, Fluid Types, and Capacities. (Table 5-A.)

FILTERS

LOCATION	ENGINE	FILTER TYPE	QUANTITY
Engine Oil:	Cummins 6CTA8.3	Cummins #LF3000	1 each
Engine Fuel:	Cummins 6CTA8.3	Cummins #FS1212	1 each
Air Filter:	Cummins 6CTA8.3	Cummins #256837	1 each
Hydraulic Oil Filters:	-----	Pall 750OSDS8H	2 each
Hand Pump Filter:	-----	Fairley Arlon FA35-10	1 each

ENGINE OIL TYPES AND CAPACITIES

LOCATION	ENGINE	OIL TYPE	CAPACITY
Hydraulic Oil-Main:	-----	Mobil EAL 224 Veg.	220 gallons
Engine Oil:	Cummins 6CTA8.3	SAE 15W40	40 quarts
Engine Water:	-----	50/50 Water/Glycol	27 gallons
Fan Drive:	-----	Multi-Purpose Grease	
Governor Control:	-----	Multi-Purpose Grease	
GearBox:	-----	Mobil Gear 626	

See small sight glass in center of gearbox between hydraulic motors. Oil should be filled to this level. Change every six months.



OPERATION / MAINTENANCE MANUAL

MODEL 100 VIBRATORY HAMMER WITH MODEL 260 POWER UNIT

7032 SOUTH 196th - KENT, WA 98032 - (253) 872-0141 / FAX (253) 872-8710

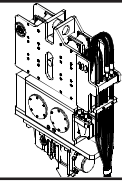

V. MAINTENANCE (Continued...)

V7-B. Power Unit - Hydraulic Fluid

When adding or changing hydraulic fluid APE uses only Mobil 224 Hydraulic Vegetable oil which is non-toxic and will not harm oil or water and is biodegradable. Consult your local oil supplier for recommendations on mixing hydraulic oils. Change hydraulic oil if it looks milky. This includes all hydraulic lines leading to and from the vibro. Milky oil indicates that water is in the oil.

V7-C. Power Unit - Draining and Filling Hydraulic Fluid Tank

1. Remove plug located on bottom of tank
2. Refill by manually pumping with hand crank.
3. Prime both the clamp and the main pump before restarting.
4. Take extreme caution that no dirt or other unwanted particles enters the system.

V7-D. Power Unit - Cleaning Hydraulic Tank Suction Filter (No suction on 1993 and newer)

1. Located inside the hydraulic tank or reservoir, is a suction filter.
2. Drain tank.
3. Remove side cover.
4. Reach into tank and unscrew filter from pipe fitting.
5. Clean with solvent and re-install. If damaged then replace.
6. Re-install filter.
7. Re-install tank cover.
8. Add new oil to tank.
9. Prime pumps.



OPERATION / MAINTENANCE MANUAL

MODEL 100 VIBRATORY HAMMER WITH MODEL 260 POWER UNIT

7032 SOUTH 196th - KENT, WA 98032 - (253) 872-0141 / FAX (253) 872-8710

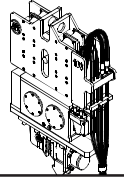

V. MAINTENANCE (Continued...)

V-7E. Power Unit - Changing Hydraulic Return Filter Element

The hydraulic return filter is mounted on the hydraulic tank inside the power unit. It is mounted high on the tank so that when the filter element is removed the oil will not drain from the hydraulic tank. The filter has a manual pop-up type indicator to tell when the filter is dirty. The pop-up indicator turns red when it is dirty.

V-7F. Power Unit - Steps to Remove the Element

1. Shut down power unit by turning off the diesel engine.
2. Place warning tag on control panel so that no one mistakenly starts the unit while filters are being changed.
3. Clean area around filter so that when it is removed there is no chance of introducing dirt into the hydraulic system.
4. Using a filter wrench, turn the filter counter clockwise and spin the filter off the filter housing.
5. Install new clean filter making sure the o-ring is in place.
6. Depress filter indicator to re-set to "clean position".

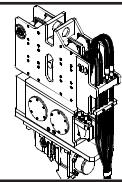

V. MAINTENANCE (Continued...)

V-8. Hydraulic Motor - Installation and Start-Up. - Figure 5A.

Fluid

For extensive information on the selection of fluids and for application conditions, please consult our data sheets HE 90220 (mineral oils), BE 90022* (environmentally acceptable hydraulic fluids) or HE 92 223 (fire resistant fluids).

You might have to consider reduced operating data with HIF-fluids and environmentally acceptable hydraulic fluids. Please contact our technical department.

Operating viscosity range

In order to obtain optimum efficiency and service life, we recommend that the operating viscosity (at operating temperature) be selected from within the range:

$$\nu_{opt} = \text{Operating Viscosity } 16 \dots 30 \text{ mm}^2/\text{s}$$

referred to the circuit temperature in closed circuits and to tank temperature in open circuits.

Viscosity limits

The limiting values for viscosity are as follows:

ν_{min} = 10 mm²/s
short term at a maximum permissible drain temperature of 90° C.

ν_{max} = 1000 mm²/s
short term on cold start

Selection diagram

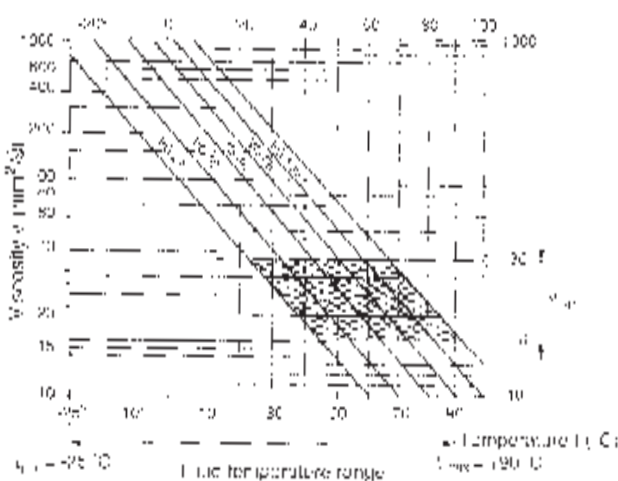

Notes on the selection of the Hydraulic Fluid

In order to select the correct fluid, it is necessary to know the operating temperature in the circuit in relation to the ambient temperature. In an open circuit, the tank temperature and in a closed circuit, the loop temperature.

The hydraulic fluid should be selected so that, within the operating temperature range, the operating viscosity lies within the optimum range (ν_{opt}) (see shaded section of the selection diagram). We recommend that the highest possible viscosity range should be chosen in each case.

Example: At an ambient temperature of X °C, the operating temperature is 60 °C. Within the operating viscosity range (ν_{opt} , shaded area) this corresponds to viscosity ranges VG 46 or VG 68. VG 68 should be selected.

Important: The working oil (base drain oil) temperature is influenced by pressure and motor speed and is always higher than the ambient temperature. However, at no point in the circuit may the temperature exceed 90° C.

If it is not possible to comply with the above conditions because of extreme operating parameters or high ambient temperatures, please consult us.

Filtration of fluid

The better the filtration, the longer the service life of the axial piston unit.

In order to ensure correct functioning of the unit, a minimum level of cleanliness is:

- NAS 1638, class 9 or
- class 6 to SAE, ASTM, AIA or
- class 18/15 to ISO/DIS 1400 is required.

If this degree of cleanliness cannot be maintained, please consult us.

Direction of flow

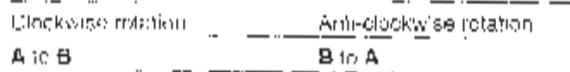

Speed range

Minimal speed n_{min} is not limited. Where smooth operation is required, n_{min} should not fall below 50 rpm. For maximum speeds see the table on page 6.

Installation position

Optional: The motor housing must be filled with fluid prior to commissioning, and must remain full whenever it is operating.

For extensive information on installation position, please consult our data sheet HE 90 270 before completing your design work.

Symbol

- Ports
- A, B - Service ports
- T - Drain port

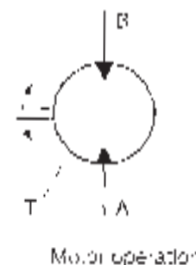

Motor operation



OPERATION / MAINTENANCE MANUAL

MODEL 100 VIBRATORY HAMMER WITH MODEL 260 POWER UNIT

7032 SOUTH 196th - KENT, WA 98032 - (253) 872-0141 / FAX (253) 872-8710

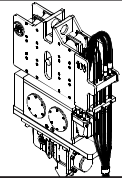

VI. VIBRO TROUBLE-SHOOTING

The following table lists some possible problems, causes and solutions. If a serious problem should occur, contact the factory for additional service information.

Table 6-A. Vibro Trouble-Shooting Index

ITEM	PROBLEM	ITEM	PROBLEM
1.	Oil Blowing Out Between Gear box and Hydraulic Motor	6.	Vibrator Won't Start When Start Button is Engaged
2.	Vibro Gearbox is Too Hot	7.	Clamp Won't Open When Clamp Open Switch is Engaged
3.	Excess Oil in the Gearbox	8.	Vibro Won't Come Up to Normal Operating Speed
4.	Oil Blowing Out From Pop-Off Valve	9.	Vibro Won't Stop When Stop Button is Engaged
5.	Opening and Closing Clamp Jaws Seems Spongy or Slow		

Possible Cause

Remedy

1. Oil Blowing Out Between Gearbox and Hydraulic Motor

The breather may be plugged or damaged.

Remove the breather and clean it. If the breather is damaged replace it.

O-rings may not be sealing properly

Check the o-rings between the gearbox top plate and the motor. Clean the seal areas and replace the o-rings if needed.

2. Vibro Gearbox is Too Hot

Oil level may be too high.

Make sure the gearbox is level. Remove the oil over fill plug (located on the gearbox next to the sight gage). If oil flows out, the oil level is too high and must be lowered.

Oil may be too dirty.

Look at oil in the sight gage. If the oil is black or milky it must be replaced. If you are still not sure, remove the case drain plug and check the oil.

3. Excess Oil in the Gearbox

The seal between the gearbox and the hydraulic motor may be bad and is allowing oil to flow directly into the gearbox.

Remove the motor from the face of the gearbox. Check and clean the seal area, replace the seal if it looks bad.

4. Oil Blowing out Pop-Off Valve

Blocked flow in case drain line.

Check case drain line to see if it is pinched.

Check case drain line for proper connection tightness.

Valve may be bad.

Remove and check the valve. Replace the valve if needed.

One or both motors may be damaged.

Remove the motors and have them checked for damage. Replace if needed.



OPERATION / MAINTENANCE MANUAL

MODEL 100 VIBRATORY HAMMER WITH MODEL 260 POWER UNIT

7032 SOUTH 196th - KENT, WA 98032 - (253) 872-0141 / FAX (253) 872-8710

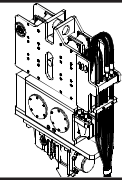

VI. VIBRO TROUBLE-SHOOTING (Continued...)

Possible Cause

Remedy

5. Opening and Closing Clamp Jaws Seems Spongy or Slow

The plunger shaft may not be properly lubricated or may need cleaning.

Remove the movable jaw from the clamp. Inspect the plunger shaft and check for lubrication or debris build up. Clean the shaft if needed and then lubricate using the grease zerk on the clamp body.

The clamp hoses may have air in them and may need bleeding.

Follow the procedures listed in this manual (page 4-3, Section IV-5.) for bleeding the clamp attachment hydraulic hoses.

6. Vibrator Won't Start When Start Button is Engaged.

Diesel engine is not running.

Start diesel engine.

Start relay contacts may not be closing.

Press and hold the Start Button on the pendant. If vibro starts, replace Start Relay.

Hoses may be connected improperly.

Check hoses and make connection corrections if required.

Hydraulic motor may not be operating properly.

Remove hydraulic motor from the vibro. Leave the hoses connected. Run the power unit engine at approx. 1200 rpm. and press the start button. If motor runs, re-attach it to the vibro. If the motor does not run, it must be replaced.

Vibro gearbox may be frozen up.

If motor is working fine and the drive pressure appears normal, then the vibro gearbox may be frozen and in need of repair.

Drive pressure is too low.

Manually close start valve at the drive manifold. If vibro will not start, replace the start valve. If vibro still will not start, replace the drive pump.

7. Clamp Won't Open When Clamp Open Switch is Engaged.

Vibrator is running.

The clamp won't open while the vibro is in operation. To open the clamp, stop the vibro.

Diesel engine may not be running.

Start the power unit engine and allow clamp pressure to build.

There may be an electrical failure.

Check for the following:

- Defective clamp switch.
- Broken or loose wire in the pendant or pendant cable.
- Defective OPEN solenoid.
- Broken or loose wire between main power switch and START relay.
- Defective or sticking clamp timing delay relay.
- Broken or loose wire between main power switch and amphenol connector.

The clamp pump may be defective.

Check clamp pump for slipping belts and tighten if required. If clamp won't open, replace clamp check valves. If clamp still won't open, replace the clamp pump.



OPERATION / MAINTENANCE MANUAL

MODEL 100 VIBRATORY HAMMER WITH MODEL 260 POWER UNIT

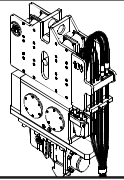

7032 SOUTH 196th - KENT, WA 98032 - (253) 872-0141 / FAX (253) 872-8710

VI. VIBRO TROUBLE-SHOOTING (Continued...)

Possible Cause

Remedy

8. Vibro Won't Come Up to Normal Operating Speed

Defective hydraulic motor or drive pump.

If vibration frequency has been verified lower than normal, Replace the hydraulic motor. If performance improves. If vibro still operates below normal speed, replace drive motor pump.

9. Vibro Won't Stop When Stop Button is Engaged

There may be an electrical failure.

Check for the following:

- Defective STOP button.
- Broken or loose wire in the pendant or pendant cable.
- Defective START relay.
- Defective motor START valve.



OPERATION / MAINTENANCE MANUAL

MODEL 100 VIBRATORY HAMMER WITH MODEL 260 POWER UNIT

7032 SOUTH 196th - KENT, WA 98032 - (253) 872-0141 / FAX (253) 872-8710

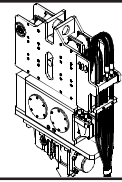

VII. MODEL 260 POWER UNIT

VII-1. Hydraulic Circuitry.

There are three Hydraulic Circuits on the Model 260 Power Unit.

VII-1A. Hand Fill Pump.

A Hand Operated Pump (item #1) is provided for transferring Hydraulic Oil into Power Unit Reservoir. When filling the Reservoir, make sure that any hoses and/or fittings in contact with the new oil is thoroughly cleaned before using.

VII-1B. Clamp Circuit.

The Clamp Circuit is isolated from the Drive Circuit. The pump (item #8) is a 5000psi, 1.16 cu. in. fixed displacement pump; so, any time the engine is running, oil is passing through the circuit. When the Clamp switch is in the 'off' position, oil is passed through the 'tandem center spool of the four way solenoid valve (item #9b), then back through the oil return line to the Reservoir. When the Clamp switch is in the 'Open' position, the 'A' solenoid on Valve #9b will be energized, causing oil to be directed to the 'rod end' of the Clamp cylinder, to open the Clamp jaws. When the Clamp is fully open, pressure will build in the circuit to the 3800psi relief setting on the Pressure Relief Valve (item #9d). During this process, the Pressure in the circuit should be monitored on the 'Clamp Open' pressure gage.(item #13a). When the Clamp switch is in the 'Closed' position, the 'B' solenoid on Valve #9b will be energized, causing oil to be directed to the 'blind end' of the Clamp cylinder, to close the Clamp jaws. When the Clamp is fully closed, pressure will build in the circuit until the oil pressure reaches 3500psi. At 3500psi, the Oil Pressure Switch (item #9f) is tripped, to open an electrical circuit, to de-energize the 'B' solenoid on valve #9b. The Pilot Check Valve (item #9c) will maintain oil pressure in the Clamp cylinder. If the Clamp pressure should drop below approx. 3300psi, the contact in the Pressure Switch will close, to energize the 'B' solenoid again. During this process, the pressure in the circuit should be monitored on the 'Clamp Closed' pressure gage.(item #13b) If the Power Unit is used to drive equipment other than a Vibro, the Relief Valve (item#9d) and the Pressure Switch (item#9f) settings may need to be raised (4500psi max.). Quick disconnect couplers permit de-coupling of the Clamp hoses at the Power Unit.

VII-1C. Drive Circuit.

A tandem gear pump (item #10) supplies the oil for the Eccentric Drive circuit to the Drive Manifold (item #11a). Three valves are attached to the Drive Manifold; a Vented Pressure Relief Valve (item #11d), a four-way valve (item #11b), and a four Way Pilot Valve (item#11c). When the vent line on the relief valve is not blocked, the relief valve will allow oil to flow to tank at a very low pressure. When the vent line is blocked, the relief pressure will be raised to approximately 3500psi. The speed at which the relief pressure can be changed is controlled by a needle valve (item #11g). When both solenoids on the four way, pilot Valve (item 11c) are de-energized, all the pilot lines between the pilot valve, the Main Valve Spool Actuators, and the vent line from the Pressure Relief Valve (item #11d) are at tank pressure; so, the Main Valve Spool is centered, and the Relief Valve vent line is not blocked, allowing the oil from the pump to pass back to tank through the 'Open Center Spool' of the Drive Valve, and/or through the Pressure Relief Valve (item #11d) at a very low pressure. A small amount of pressure to the Pilot Valve is maintained by the resultant pressure drop through the Main Valve Spool. When one of the solenoids on valve #11c is energized, oil pressure is routed to one of the Main Valve Spool Actuators, and through the Shuttle Valve (item #11e) to block the vent line from the Relief Valve (item #11d). A soft start is effected by controlling the 'shift speed' of the Main Valve Spool via the orifice feeding the Pilot Valve. Once the Main Spool has shifted, oil is directed to the Drive Motor. The Drive Operating Pressure can be monitored on the Drive Pressure Gage (item #13d). Oil returning to the Reservoir passes through the Cooler (item #12),and the Return Oil Filter (item #7) before re-entering the Reservoir.

Quick-disconnect couplings permit de-coupling of the Drive and Case Drain Hoses at the Power Unit.

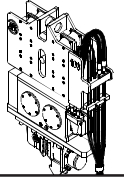

VII. MODEL 240 & 260 POWER UNIT (Continued...)

VII-1H. Hydraulic Schematic.

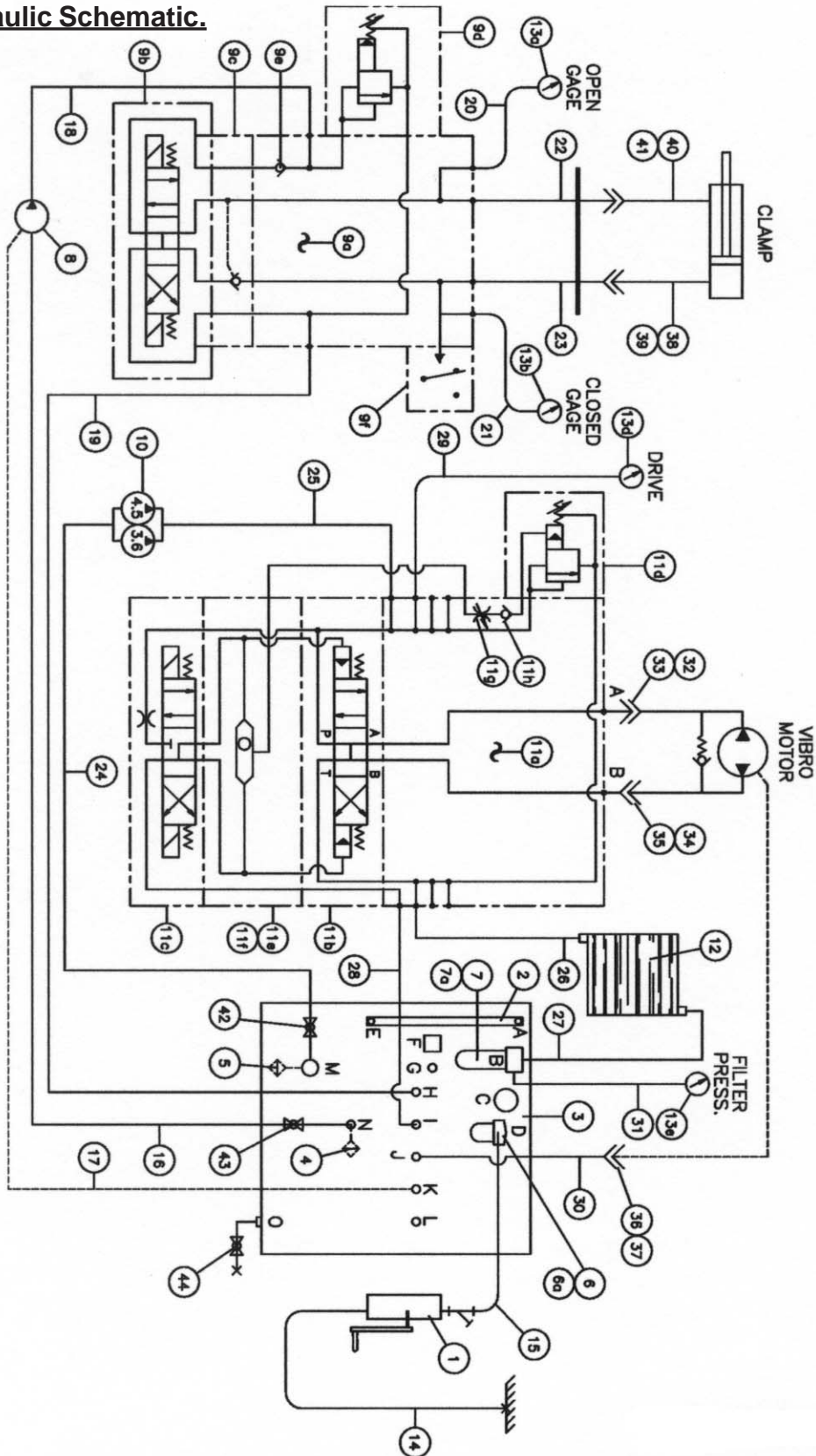
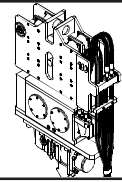

Figure 7-A. Power Unit Hydraulic Schematic. (See Page 2-12, Table 2-H.)

OPERATION / MAINTENANCE MANUAL

MODEL 100 VIBRATORY HAMMER WITH MODEL 260 POWER UNIT

7032 SOUTH 196th - KENT, WA 98032 - (253) 872-0141 / FAX (253) 872-8710



VII. MODEL 260 POWER UNIT (Continued...)

VII-2. Electrical Controls: (Understanding How They Work)

The Main Control Panel (located behind one of the doors on the left side of the Power Unit) contains all of the equipment necessary to Start, Control, and Monitor the Engine, as well as control the Vibro functions. Remote control of the Vibro functions can be achieved by plugging either a Remote Pendant Switch, or a Radio Receiver into the 12 pin receptacle, located on the bottom of the panel. The Pendant Switch will allow the operator to move about in approx. a 50 ft radius of the Power Unit. The Radio will allow the operator to move about in approx. a 400 ft radius of the Power Unit.

VII-2A. Main Circuit Breaker

A circuit breaker is provided to protect the control wiring in the event of an electrical overload or a shorted circuit. If the circuit breaker should trip, find and repair the fault, then reset the breaker by pressing the circuit breaker reset button on the face of the Control Panel.

VII-2B. Tachometer

A digital tachometer, located on the front of the control panel, is provided to monitor the engine RPM. A magnetic sensor picks up a signal from the flywheel, and sends it to the tachometer. If there is reason to doubt the accuracy of the tachometer, check the engine RPM with a phototach, then calibrate the tachometer gage. The factory should be consulted for proper setting of the tach switches.

VII-2C. Hourmeters

Two hourmeters are on the Control Panel, one on the face of the panel, and one inside the panel. The hourmeter on the face of the panel monitors the time that the engine is running. The hourmeter inside the panel monitors the time that the "Forward Drive" is operating.

VII-2D. Engine Safety Shutdown Switch (Murphy Magnetic Switch)

Mounted to the back side of the Control Panel Door, is a Murphy Magnetic switch with a manual reset button protruding through the front of the Panel Door. When the contact on the switch is closed, power is supplied to the fuel valve solenoid, the hourmeter, and the "System OK" light. When the contact is open, the above items will be de-energized, and the engine will not run. The contact can be manually closed by pressing the "Reset" button on the face of the control panel. The contact will remain latched closed, unless the coil on the switch is energized. Each time the coil is energized, the contact will be unlatched, and the contact will open, to stop the engine. There are five switches that can energize the coil on the Murphy magnetic Switch, to stop the engine, (Engine Oil Pressure Gage, Engine Coolant Temperature Gage, Hydraulic Oil Temperature Gage, Hydraulic Oil Level Switch, and Emergency Stop Button on either the Pendant Switch, or the Radio).

VII-2E. Murphy "Engine Oil Press" gage

The Engine Oil Pressure Gage is located on the door of the Main Control Panel. A low cutoff switch is located inside the Murphy "Engine Oil Press" gage. When the engine oil pressure is too low, the switch will close to energize the coil in the Murphy Mag Switch. The cutoff pressure has been set at the factory. If the setting should need to be changed, use the adjustment screw provided in the front of the gage. A 1/16" allen wrench is required. Each time the engine is to be started, the Murphy Mag Switch coil will be energized by the switch in this gage. To start the engine, one must press and hold the manual reset button on the Murphy Mag Switch until sufficient engine oil pressure is achieved. Sufficient oil pressure has been achieved when the "Oil Press" light on the face of the Control Panel goes out.)



OPERATION / MAINTENANCE MANUAL

MODEL 100 VIBRATORY HAMMER WITH MODEL 260 POWER UNIT

7032 SOUTH 196th - KENT, WA 98032 - (253) 872-0141 / FAX (253) 872-8710

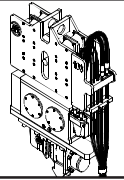

VII. MODEL 260 POWER UNIT (Continued...)

VII-2F. Murphy “Engine Coolant Temp” gage

The Engine Coolant Temperature Gage is located on the door of the Main Control Panel. A high cutoff switch is located in the Murphy “Engine Coolant Temp” gage. When the engine temperature is too high, the switch will close to energize the coil in the Murphy Mag Switch. The cutoff pressure has been set at the factory. If the setting should need to be changed, use the adjustment screw provided in the front of the gage. A 1/16” allen wrench is required. (Do not set the cutoff temperature above 220 deg F. without factory permission)

VII-2G. Murphy “Hyd Oil Temp” gage

The Hydraulic Oil Temperature Gage is located in the Gage Assembly on the left of the Control Panel. A high cutoff switch is located in the Murphy “Hyd Oil Temp” gage. When the hydraulic oil temperature is too high, the switch will close to energize the coil in the Murphy Mag Switch. The cutoff pressure has been set at the factory. If the setting should need to be changed, use the adjustment screw provided in the front of the gage. A 1/16” allen wrench is required.

VII-2H. Hydraulic Oil Level Float Switch

The “Hyd Oil Level” float switch is located in the hydraulic oil reservoir, next to the sight gage. A glass window is provided in the switch so that the float and oil level can be observed. If the oil level gets too low, the switch will close to energize the coil in the Murphy Mag Switch.

VII-2I. Pendant “Emergency Stop” button

To stop the engine in an emergency, press the “Emergency Stop” button on the hand held Pendant Switch. This “Emergency Stop” switch will work, regardless of the position of the “Local-Pendant” selector Switch.

VII-2J. Radio “Emergency Stop” Button

To stop the engine in an emergency, press the red “Emergency Stop” button located near the antenna on the radio transmitter. This switch will work, regardless of the position of the “Local-Pendant” selector switch. NOTE: In order for the radio “Emergency Stop” button to work, both the Radio Receiver and the Radio Transmitter have to have been on, and operational.

VII-2K. Pilot lights

There are five pilot lights on the face of the control panel that are associated with the Safety Shutdown Switch discussed above.

1. **“System OK” light.** A lit “System OK” light is an indication that the Engine Oil Pressure, Engine Coolant Temperature, Hydraulic Oil Temperature, and the Hydraulic Oil Level are all okay. When the “System OK” light is not lit, the engine will have been automatically stopped. The problem can be detected by observing the following lights.
2. **“Engine Oil Press” light.** Any time the engine oil pressure is too low, this light will be on, (with the following exception). If the “Engine Coolant Temperature Gage”, the Hydraulic Oil Temperature Gage, or the Hydraulic Oil Level Switch has stopped the engine, the “Engine Oil Press” light will not be on; but, one of the following lights will be on.
3. **“Engine Coolant Temp” light.** If the Engine Coolant Temp is too high, this light will be on.
4. **“Hydraulic Oil Temp” light.** If the Hydraulic Oil Temperature is too high, this light will be on.
5. **“Hydraulic Oil Level” light.** Any time the Hydraulic Oil Level is too low, this light will be on.

In addition to the above, there is a pilot light in each of the terminal connectors on the solenoid valves. By observing these lights, one can tell which solenoids are energized.



OPERATION / MAINTENANCE MANUAL

MODEL 100 VIBRATORY HAMMER WITH MODEL 260 POWER UNIT

7032 SOUTH 196th - KENT, WA 98032 - (253) 872-0141 / FAX (253) 872-8710

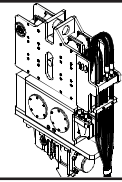

VII. MODEL 260 POWER UNIT (Continued...)

VII-2L. Engine Control Switch “OFF-ON-START”

The Engine Control Switch is located on the front of the control panel, and is used to start and stop the diesel engine, as well as control power to all other electrical equipment on the power unit. This switch must be in the “on” position before the engine or any of the other electrical components will operate. The “off” and “on” positions are detented, but the “start” position is spring loaded to the “on” position. Turning the switch to the “start” position will energize the starter motor on the engine.

VII-2M. “LOCAL— PENDANT” Switch

This switch is also located on the main control panel, and determines the location from which the vibro can be operated. The vibro can not be operated from more than one location at a time. When this switch is turned to the “local” position, the vibro can be operated only by the switches on the power unit control panel. In the “pendant” position, operation of the vibro is controlled by either the Hand Held Pendant Switch, or the Radio (depending on which one is plugged into the bottom of the Control Panel).

CAUTION should be used when changing the position of this switch. Check to make sure that all of the Drive “Forward/Reverse” switches, and “Clamp” switches (including the Radio) are turned “off” before turning this switch. If any one of the above switches are “on”, the vibro eccentrics or clamp could be accidentally activated, causing mechanical damage or personal injury.

If neither the Hand Held Pendant nor the Radio is plugged into the Receptacle on the bottom of the Control Panel, this switch must be in the “local” position before the engine can be started.

VII-2N. Governor Control Switches “RAISE/off/LOWER”

Governor Control switches can be found on the Main Control Panel, the Held Pendant, and/or the Radio Transmitter. The “Local-Pendant” switch determines which one is operable. To increase the engine rpm, turn the appropriate governor control switch to the “Raise” position. To decrease the engine rpm, turn the switch to the “Lower” position. On power units equipped with Caterpillar engines, the switches are connected directly to the engine governor. On power units equipped with Cummins engines, the switches control a Murphy Actuator, which in turn, operates a control arm on the engine governor. On both the Caterpillar and Cummins models, there is a manual throttle control, which can override the electric control. The electric control cannot lower the engine rpm below that set by the manual throttle control.

VII-2O. Clamp Control Switches (“OPEN-off-CLOSE”)

A Clamp Control Switch can be found on the Main Control Panel, the Hand Held Pendant, and/or the Radio Transmitter. The “Local-Pendant” switch determines which one is operable.

The Clamp Control Switches on the Control Panel and the Hand Held Pendant are detented in the “off” and “close” positions. The “open” position is spring loaded back to the “off” position.

When the ‘active’ Clamp Control Switch is in the “off” position, oil from the Clamp Pump is routed through the Clamp Solenoid Valve back to tank.



OPERATION / MAINTENANCE MANUAL

MODEL 100 VIBRATORY HAMMER WITH MODEL 260 POWER UNIT

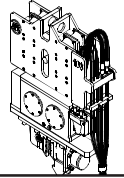

7032 SOUTH 196th - KENT, WA 98032 - (253) 872-0141 / FAX (253) 872-8710

VII. MODEL 260 POWER UNIT (Continued...)

VII-20. Clamp Control Switches (“OPEN-off-CLOSE”) (Continued...)

When the ‘active’ Clamp Control Switch is turned to the “open” position, The “open” solenoid on the Clamp Valve is energized, causing oil to be directed to the rod end of the Clamp Cylinder, provided the drive “Forward/Reverse” Switch is in the “off” position. (The clamp “open” solenoid cannot be energized when the “Drive Forward” switch is activated.) If the Clamp Control Switch is held in the “open” position after the clamp is fully open, oil pressure will build in the system until oil is flowing over a pressure relief valve, creating heat.

When the ‘active’ Clamp Control Switch is turned to the detented “Close” position, the “close” solenoid on the Clamp valve is energized, causing oil to be directed to the blind end of the Clamp Cylinder. Once the Clamp is closed, and sufficient oil pressure (3500psi) has built in the system, a pressure switch will open the circuit to the solenoid valve, and energize a pilot light located in the Clamp Control Switch Operator. A lit pilot light in the Clamp Control Switch Operator is an indication that there is enough oil pressure in the clamp circuit to safely run the vibro eccentrics.

If oil pressure in the Clamp circuit should bleed off to a predetermined level(3300psi), the pressure switch will de-energize the pilot light, and re-energize the “close” solenoid on the Clamp valve until pressure in the clamp circuit reaches 3500psi again. This cycle will continue until the Clamp switch is turned to the “off” position.

Operation of the Clamp “open/close” switch on the radio transmitter is similar, but slightly different, in that the switch on the Radio Transmitter is not detented in the “close” position.

The first time the Clamp switch on the transmitter is moved to the “close” position, the radio output signal to the “close” solenoid on the Clamp valve will be latched on. The oil pressure switch will function the same as above, but the operator will have to look on the control panel or the hand held pendant switch to observe the pilot light.

The next time the Clamp switch on the transmitter is moved to the “close” position, the radio output signal to the “close” solenoid on the Clamp valve will be turned “off”. Each time the switch is moved to the “close” position, the radio output will be alternately turned “on”, or “off”. The radio’s Clamp “close” output signal can also be turned “off” by moving the switch to the “open” position.

As long as the Clamp switch on the radio transmitter is held in the “open” position, the radio will send an output signal to the “open” solenoid on the Clamp valve, provided both the “Drive Forward” and “Drive Reverse” outputs are turned off. (The clamp “open” solenoid cannot be energized when the “Drive Forward” output is activated.) If the Clamp Control Switch is held in the “open” position after the clamp is fully open, oil pressure will build in the system until oil is flowing over a pressure relief valve, creating heat.



OPERATION / MAINTENANCE MANUAL

MODEL 100 VIBRATORY HAMMER WITH MODEL 260 POWER UNIT

7032 SOUTH 196th - KENT, WA 98032 - (253) 872-0141 / FAX (253) 872-8710

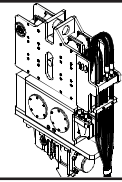

VII. MODEL 260 POWER UNIT (Continued...)

VII-2P. Drive Control Switches (“FORWARD/off/REVERSE”)

Drive Control Switches can be found on the Main Control Panel, the Hand Held Pendant, and/or the Radio Transmitter. The “Local-Pendant” Selector Switch determines which one is operable.

The Drive Control Switches on the Control Panel and the Hand Held Pendant are detented in all three positions. They must be in the “off” position, before the engine can be started.

When operating a Drill, both the “Forward” and “Reverse” positions can be used. The “Forward” position would be used to drive the drill forward. The “Reverse” position would be used to drive the drill backwards.

When operating the eccentrics on a vibro, only the “Forward” drive should be used. If the “Reverse” drive is used, the majority of the oil will pass through the anti-cavitation valves located in the vibro suppresser housing, and the vibro eccentrics will not run properly.

The operation of the switches on the Radio Transmitter are similar to the Control Panel and Pendant operation, with the following exception. There are two switches on the transmitter, one for “Forward”, and one for “Reverse”. Neither is detented. When the “Drive Forward” switch on the transmitter is moved to the “on” position, the “Drive Forward” output signal from the radio is latched “on”. To turn the “Drive Forward” output signal “off”, move the “Drive Forward” switch on the transmitter to the “off” position. The “Reverse” output works the same way.

It is possible to plug reverse the drive motor by alternately moving the “Forward” and “Reverse” switches on the transmitter to the “on” position, without using the “off” positions. This is hard on the equipment, and should be avoided. If a drive is turned “on”, it should always be turned “off”, and the equipment allowed to stop, before the opposite drive is turned “on”.

VII-2Q. Preparing the Electrical System for Engine Startup.

The following procedure should be followed at Engine Startup:

1. The Circuit Breaker must be closed (Pushed in and locked).
2. Turn the Clamp Switches on both the Control Panel and the Pendant to the ‘Off’ position.
3. Turn the Drive Switch on both the control panel and the Pendant to the ‘Off’ position.
4. If neither a Hand Held Pendant, nor a Radio is plugged into the receptacle on the bottom of the Control Panel, this switch must be in the ‘Local’ position.
5. Check to make sure that both the Manual Throttle Control, and the Governor Control is properly set.
6. Turn the Engine Control Switch to the ‘On’ position.
7. Check the Pilot Lights on the face of the Control Panel. If any of the lights, other than the “Engine Oil Pressure” light is on, correct the problem before proceeding. If the ‘Engine Oil Pressure’ light is on, proceed to step #8.
8. Depress and hold the button on the Engine Safety Shutdown Switch (Murphy Switch). This button must be depressed until Engine Oil Pressure is present.
9. Turn the Engine Control Switch to the ‘Start’ Position to engage the Starter Motor.
10. Once Engine Oil Pressure is present, release the Emergency Shutdown Switch.



OPERATION / MAINTENANCE MANUAL

MODEL 100 VIBRATORY HAMMER WITH MODEL 260 POWER UNIT

7032 SOUTH 196th - KENT, WA 98032 - (253) 872-0141 / FAX (253) 872-8710

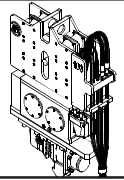

VII. MODEL 260 POWER UNIT (Continued...)

VII-2R. Electrical Schematic with Pendant Control - Fig. 7-B1.

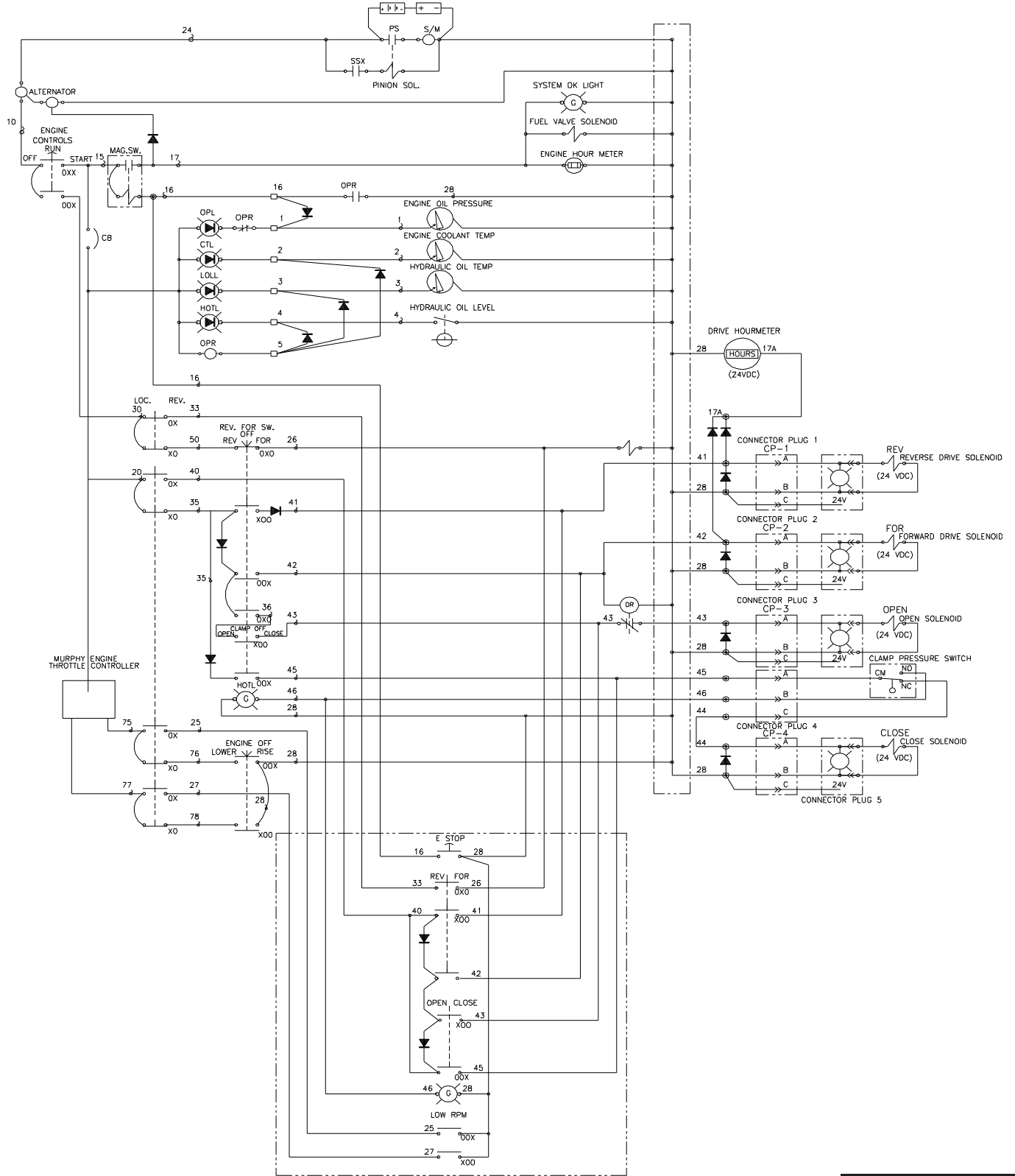

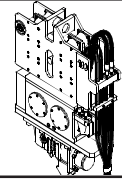

VII. MODEL 260 POWER UNIT (Continued...)

VII-2S. Electrical Schematic with Radio Control - Fig. 7-B2.

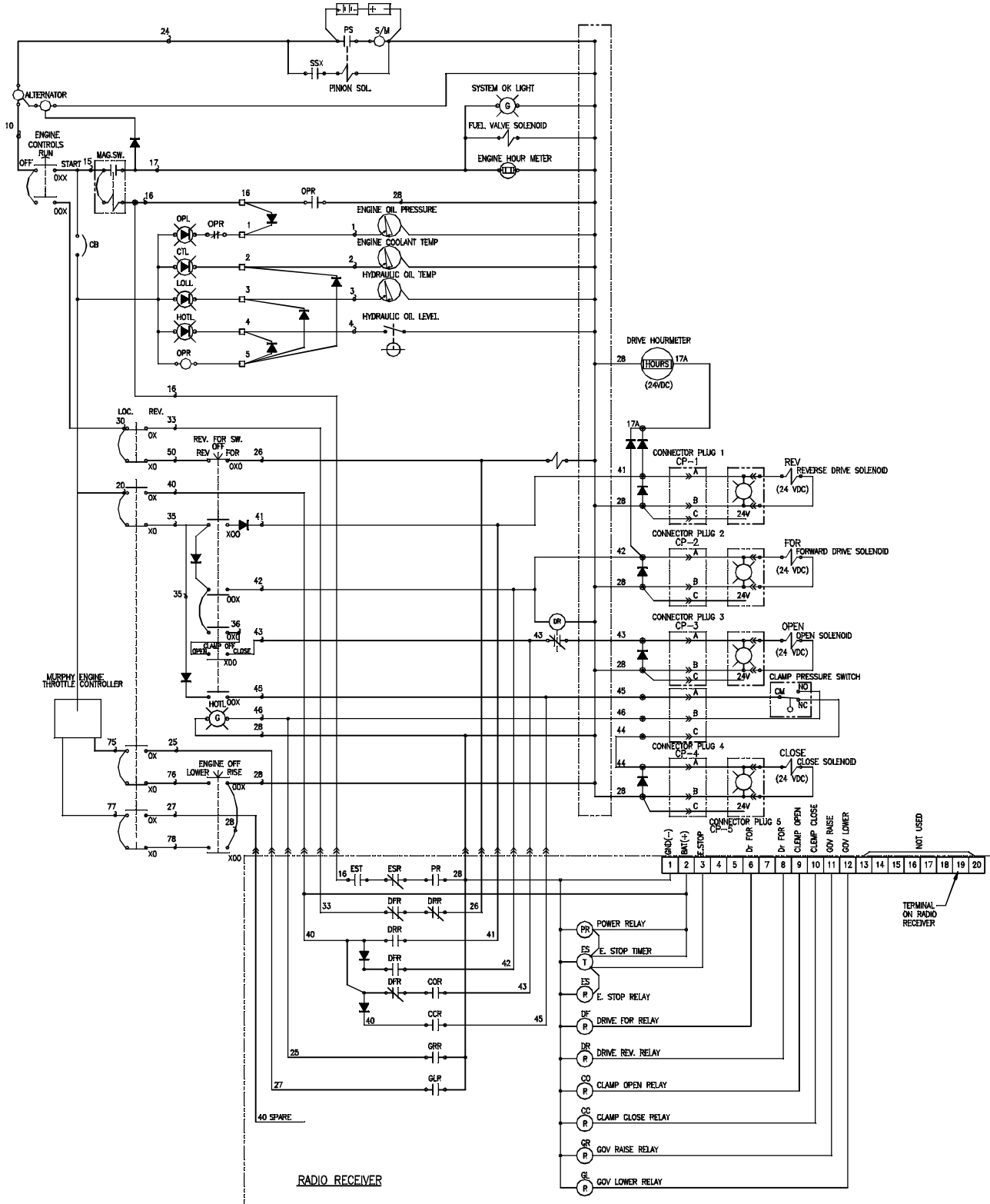

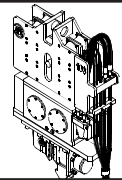

VII. MODEL 260 POWER UNIT (Continued...)

VII-3. Remote Control Pendant

A "REMOTE HAND HELD CONTROL PENDANT" is provided to allow operation of the power unit at a distance of up to 50 feet (15 meters) and can be extended using 50 foot extension cables. The "REMOTE HAND HELD CONTROL PENDANT" is connected to the control panel via a multiconnector plug.

The Pendant Switch is particularly handy as a trouble shooting tool, in that the operator can position himself near the Control Valves while checking them. To make the Pendant Switches operable, turn the 'Local-Pendant' Switch to the 'Pendant' position, and the Engine Control Switch to the 'On' Position. (The Engine does not need to be running.) Each time a solenoid is energized, a pilot light on the connector to that solenoid should light up.

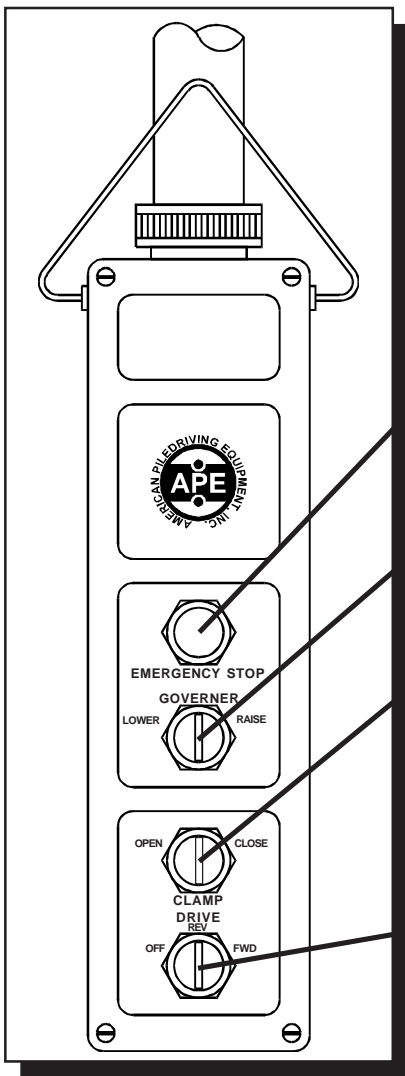

ENGINE EMERGENCY SHUTDOWN SWITCH
Press and hold to shut engine off. Do not use to shut engine off at the end of shift. Shut unit off at panel at end of shift. Button is for emergency only.

ENGINE THROTTLE "RAISE/LOWER" RPM
Three Position Switch. Press and hold button to raise or lower deisel engine rpm.

CLAMP OPEN/CLAMP CLOSE
Lighted switch. Move to **close** to extend jaw and clamp vibro to pile. Light comes on when clamp is closed and locked. Turn to **open** to retract jaw and release vibro from pile. Switch must remain in **closed** position to hold clamp to pile. Sometimes the light will not come on. It could be burnt out or shorted. Check clamp pressure gauge and make sure it reads at least 3800 psi before vibrating any pile. Contact APE if light is not working.

FORWARD/OFF/REVERSE
Three position switch. Turn to **forward** to operate vibro. Turn to **off** to stop vibro. Turn to **reverse** when using power unit to run a drill motor. Vibro is not supposed to vibrate in reverse. If it does then switch the two yellow cables labled "drive" and "reverse" located on the other side of the control panel.

Figure 7-C. Remote Control Pendant

WARNING: Never leave vibro clamped to a pile without the crane line attached. The clamp cylinder could bleed off causing the vibro to drop. Never hoist a pile in the air without a safety line attached to the pile. Should the clamp close line become damaged and leak, the clamp cylinder could lose pressure and drop the pile.

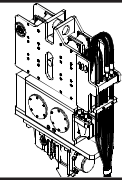

VII. MODEL 260 POWER UNIT (Continued...)

VII-3A. Remote Pendant Wiring Diagram

The following is the pin wiring configuration and the wire colors of the amphenol connectors for the remote control pendant cable.

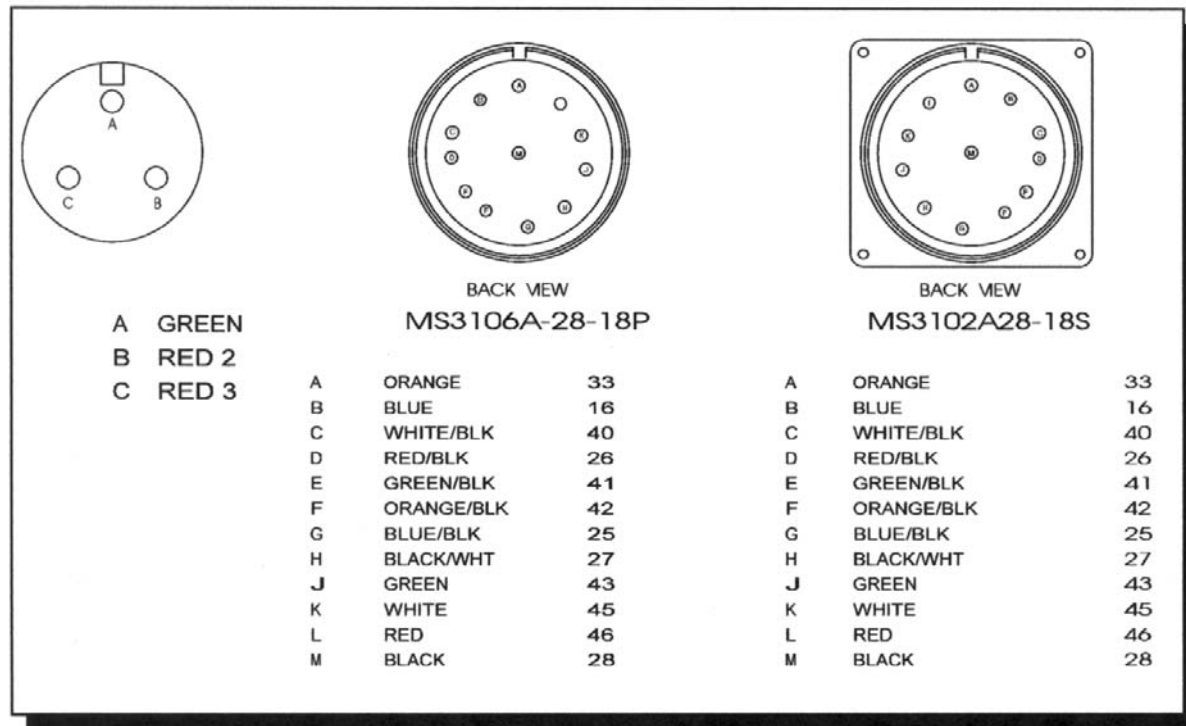

Figure 7-D. Remote Pendant Wiring Diagram



OPERATION / MAINTENANCE MANUAL

MODEL 100 VIBRATORY HAMMER WITH MODEL 260 POWER UNIT

7032 SOUTH 196th - KENT, WA 98032 - (253) 872-0141 / FAX (253) 872-8710

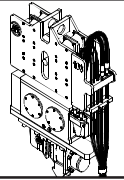

VII. MODEL 260 POWER UNIT (Continued...)

VII-4. Radio Control Equipment.

VII-4A. Overview.

By unplugging the Hand Held Pendant, and plugging in a Radio Receiver in it's place, all of the functions that are normally controlled by the Pendant can be controlled by a Hand Held Radio Transmitter, allowing the operator to position himself almost anywhere within a 400 foot radius of the Power Unit. The MICROTRONICS radios used on APE equipment are designed to produce reliable performance without interference from other radio equipment operating near the same frequency. The 'SMART LOGIC' in each radio receiver gives each incoming signal a series of three tests, all of which must be passed before the signal is considered valid, and accepted to produce an output signal.

(An FCC license is not required to operate these radios.)

The radio equipment supplied consists of three parts, an Antenna, a Radio Receiver, and a Hand Held Transmitter.

VII-4B. Antenna Mounting and Connection.

The antenna should be vertically mounted in an open area, at least 2 ft. away from any vertical Metal. Metal, such as a crane boom, operating too close to the antenna could create 'dead spots' in which the radio would not be able to receive a signal. The standard length for antenna cables shipped from the factory is 15 ft. One end has a fitting that will screw onto the Radio Receiver. The other end has two loose wires fitted with ring terminals. The large Ring Terminal should be connected to Ground. The small Ring Terminal should be connected to the Antenna.

See Page 2-23 (Fig. 2-L) For Radio Antenna Assembly and Parts List.

VII-4C. Receiver Mounting and Connection.

The Radio Receiver is mounted in an enclosure, along with a set of prewired output relays. If the Receiver is mounted on a vertical plane, it should be oriented so that the terminal strip on the printed circuit board is on the bottom. An external prewired pigtail with a plug is provided for connecting the Radio Receiver Assembly to the Main Control Panel. All internal connections between the Receiver printed circuit board and other equipment within the enclosure should be made via the spring loaded terminal strip, mounted along one edge of the printed circuit board. These terminals will accept 22 ga. through 14 ga. wires. To make connections, insert a small screwdriver into the hole on top of the appropriate terminal, and depress the internal spring wire clamp, while inserting a stripped wire end into the lower side hole. The wires should be stripped approx. 3/8 in.

See Page 2-19 (Fig. 2-K1, K2, K3) For Radio Receiver Assembly and Parts List.



OPERATION / MAINTENANCE MANUAL

MODEL 100 VIBRATORY HAMMER WITH MODEL 260 POWER UNIT

7032 SOUTH 196th - KENT, WA 98032 - (253) 872-0141 / FAX (253) 872-8710

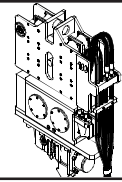

VII. MODEL 260 POWER UNIT (Continued...)

VII-4D. Radio Receiver Setup.

There are two sets of dip switches located along one edge of the receiver printed circuit board. The Set of 12 Switches Control addressing between the Transmitter and the Receiver. The switches in the Receiver and the Transmitter must be set the same, for the radio to work. These switches have been set at the factory, and should not be changed unless the factory is consulted. Each switch in the set of 8 switches controls one of the eight output functions. If a dip switch is in the 'Off' position, the corresponding output is 'momentary', meaning that the output will remain only as long as the operator is sending a signal from the transmitter. If a dip switch is in the 'On' position, the corresponding output is 'latched', meaning that once a signal has been received from the Transmitter, the output signal will remain until a second signal is sent to turn it off.

The 'Drive Forward', 'Drive Reverse', and 'Clamp Closed' dip switches should be in the 'on' position. The 'Clamp Open', 'Governor Raise', and 'Governor Lower' dip switches should be in the 'off' position.

VII-4E. Radio Operation.

In order for the radio to be operational, both the Receiver and the Transmitter must be turned 'on', and the Receiver must be 'initialized.'

To turn the Receiver 'on', turn the Engine Control Switch to the 'on' position, and the 'Local—Pendant' switch to the 'Pendant' position. Turning either switch to another position will turn the Receiver 'off'. When power is supplied to the Receiver, the 'Power Indicator' on the circuit board will be lit.

The Receiver should be turned 'on' before the Transmitter is turned 'on'. This is because, each time the Transmitter is turned 'on', a 10 second signal is sent from the Transmitter to the Receiver to 'initialize' the Receiver. While this 10 second signal is being transmitted, the 'RF Indicator' on the circuit board will be lit, and the Power Relay will be energized. If the Receiver is successfully 'initialized', the Power Relay will remain sealed in after the 'initialization' signal has ceased. Once the Receiver is 'initialized', it is ready to use. (If the Transmitter was turned on more than 10 seconds before the Receiver, the Transmitter must be turned 'off', then 'on' again, after the Receiver has been turned 'on'.)

See Page 2-24 (Fig. 2-M1, M2) For Transmitter Assembly and Parts List.

To turn the Transmitter 'on', move the small toggle switch beside the antenna on the Transmitter to the 'on' position. This switch must be 'on' before any of the other switches on the Transmitter, including the Red Emergency Stop Button, will work. If this switch should get turned 'off' while an output signal from the Receiver was 'latched' on, the signal could not be turned 'off' by the Transmitter until the Transmitter was turned 'on' again.

Operation of all the other switches on the Transmitter is covered in section VII-2.

See section VII-2J for the Emergency Stop Function.

See section VII-2N for the Governor Control.

See section VII-2O for the Clamp Control.

See section VII-2P for the Drive Control.



OPERATION / MAINTENANCE MANUAL

MODEL 100 VIBRATORY HAMMER WITH MODEL 260 POWER UNIT

7032 SOUTH 196th - KENT, WA 98032 - (253) 872-0141 / FAX (253) 872-8710

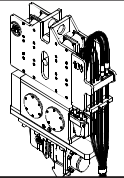

VII. MODEL 260 POWER UNIT (Continued...)

VII-4F. Radio Malfunction

Problem 1: Radio Will Not Operate

Possible Causes:

1A. No Power to the Receiver you can easily determine if there is power to the Radio Receiver by checking the 'Power Indicator Light' in the upper left hand corner of the Receiver's printed circuit board. If the indicator is not lit:

- a. Check the Circuit Breaker in the Main Control Panel
- b. Check to see that the Engine Control Switch and the 'local-Radio-Pendant' Switch are in the correct position.
- c. Check the fuse in the lower Left corner of the Receiver's printed circuit board. (If this fuse is blown, a short circuit may have occurred. Check all related wiring before replacing the fuse.)
- d. The Receiver may not Be 'initialized'. The Receiver must be 'initialized' before any 'output' signals can be produced. If the Receiver is 'initialized', the Power Relay in the lower left corner of the printed circuit board will be engaged. If the Transmitter is turned 'on' before the Receiver is turned 'on', the Receiver will not be 'initialized'. Or, if the Receiver is turned 'off', then 'on' again while the Transmitter is 'on', The Receiver will not be 'initialized'. To 'initialize' the Receiver, turn the Transmitter 'off', then 'on' again. If you are observing the Receiver, you should see the 'RF Indicator' light up for about 10 seconds, and the Power Relay should engage.
- e. No signal from the Transmitter The 'RF Indicator' light on the upper right corner of the Receiver's printed circuit board will be lit each time a signal is received from the Transmitter. Make sure that the Transmitter is turned 'on'. Check the Battery in the Transmitter. If the Transmitter is 'off', turn it 'on'. If you are observing the Receiver, you should see the 'RF Indicator' light up for about 10 seconds, and the Power Relay should engage. If the Transmitter is already 'on', press the Red Emergency Stop button located beside the antenna on the Transmitter. Check the Antenna Connections. If you are observing the Receiver, you should see the 'RF Indicator' light up for about 10 seconds, and the Power Relay should dis-engage. Turn the Transmitter 'off', then 'on' again. If you are observing the Receiver, you should see the 'RF Indicator' light up for about 10 seconds, and the Power Relay should engage. Make sure that there isn't an obstruction (crane, truck, etc.) between the Transmitter and the Receiver. Check the Dip Switches. (See section VII-4D, Page 4-13).

Problem 2 Radio appears to be working, but a Valve Will Not function.

Possible Causes:

- 2A.** Burned out Solenoids on the Valves. Each Valve is equipped with a light in the connector on each solenoid. Any time a signal is sent to the solenoid, the light will turn on. Use either the switches on the Main Control Panel or the Pendant to test the Valves for proper operation. A light, with no response by the valve, would indicate that the control is okay, but the valve is faulty. If no light is observed at the valve, assume the problem is in the wiring between the Main Control Panel and the Valve. If the Valves work okay, assume the problem is with the radio equipment.
- 2B.** Faulty Relay or wiring in the Receiver Enclosure. Check to make sure that all the relays in the Receiver Enclosure are plugged in properly. Check for broken or disconnected wires.
- 2C.** Faulty Receiver. The Radio Receiver and Transmitter have been programmed as a set at the factory. If a new Receiver is installed, use the matching Transmitter. The factory should be consulted before trying to reprogram either the Receiver or the Transmitter.



OPERATION / MAINTENANCE MANUAL

MODEL 100 VIBRATORY HAMMER WITH MODEL 260 POWER UNIT

7032 SOUTH 196th - KENT, WA 98032 - (253) 872-0141 / FAX (253) 872-8710

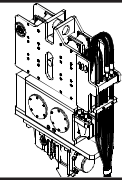

VII. MODEL 260 POWER UNIT (Continued...)

VIII. Power Unit Upgrade.

Many of the Features and Controls shown in this manual are new. This section describes the steps necessary to Upgrade an older Power Unit to the new design.

VIII-1. Upgrading to the Murphy Gages.

Many of the older Power Units use a combination of Sending Units and Cutoff Switches interconnected to Electrically Driven Gages. The new Murphy Gages have the adjustable Cutoff Switches inside.

VIII-1A. Upgrading the 'Engine Oil Pressure' Gage.

1. Remove the old 'Engine Oil Pressure' gage from the Main Control Panel.
2. Install a new Murphy Gage (Model #20P-100).
3. Remove the old Oil Pressure Sending Unit from the Engine.
4. Install an Oil Line between the Engine and the new Murphy Gage.
5. Eliminate wire #22 that went between the Old Sender and the Old Gage.
6. Remove wire #1 from the Old Oil Pressure Cutoff Switch on the Engine, and reconnect to the wire protruding from the new Murphy Gage.
7. Adjust the Cutoff Pressure on the front of the new Murphy Gage. (A 1/16 in. hex wrench is required.)

VIII-1B. Upgrading the 'Engine Coolant Temperature' Gage.

1. Remove the old 'Engine Coolant Temperature' gage from the Main Control Panel.
2. Install a new Murphy Gage (Model #20T-250-10).
3. Remove the old Coolant Temperature Sending Unit from the Engine, and install the capillary, protruding from the new Murphy Gage.
4. Eliminate wire #21 that went between the Old Sender and the Old Gage.
5. Remove wire #2 from the Old Coolant Temperature Cutoff Switch on the Engine, and reconnect to the wire protruding from the new Murphy Gage.
7. Adjust the Cutoff Temperature on the front of the new Murphy Gage. Do not set the Cutoff Temperature above 220 deg F, without factory permission. (A 1/16 in. hex wrench is required.)

VIII-1C. Upgrading the 'Fuel Pressure' Gage.

APE has determined that the Fuel Pressure Gage is unnecessary. So, all new Power Units supplied by APE do not have Fuel Pressure Gages. There is no reason to remove the Fuel Pressure Gage from your Power Unit.

VIII-1D. Upgrading the 'Hydraulic Oil Temperature' Gage.

1. Remove the old 'Hyd. Oil Temperature' gage from the Main Control Panel.
2. Install a new Murphy Gage (Model #25T-250-20 (10-70-3478)).
3. Remove the old Hyd. Oil Temperature Switch from the Hydraulic reservoir, and install the capillary, protruding from the new Murphy Gage.
4. Remove wire #4 from the old Hydraulic Oil Temperature Switch, and reconnect to the wire protruding from the new Murphy Gage.
7. Adjust the Cutoff Temperature on the front of the new Murphy Gage. The oil manufacturer should be consulted for the correct temperature. (A 1/16 in. hex wrench is required.)



OPERATION / MAINTENANCE MANUAL

MODEL 100 VIBRATORY HAMMER WITH MODEL 260 POWER UNIT

7032 SOUTH 196th - KENT, WA 98032 - (253) 872-0141 / FAX (253) 872-8710

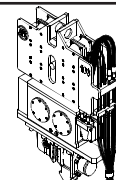

VII. MODEL 260 POWER UNIT (Continued...)

VIII-2. Upgrading the Governor Control Wiring.

The Governor Controls on older Power Units with Cummins Engines were wired so that the Operator would have to override the Murphy Shutoff Switch in order to Raise or Lower the Engine Throttle Control, when the Engine was not running. In an effort to make the Governor Control a little more User Friendly, as well as make the control for Cummins Engines consistent with Caterpillar Engines, the following change was made.

1. Feed the Murphy Throttle Controller (on the engine) with wire #20, rather than wire #17.

VIII-3. Upgrading the Drive and Clamp Switches.

The Drive and Clamp Switches on older Power Units were wired so that either the Clamp or the Drive could be activated at any time. All New Power Units are wired so that the Clamp cannot be opened while the Drive is running in the "Forward" direction.

To Upgrade, proceed as follows:

1. Install a new relay in the Main Control Panel.
 - a. -Relay Base = Idec #SH2B-05
 - b. -Relay = Idec #RH2B-DC24V
2. Feed the Relay Coil with wire Nos. 42 and 28
3. Disconnect wire No. 43 from the Receptacle going to the Clamp Open Solenoid.
4. Reconnect wire No. 43 to one side of a Normally Closed Contact on the New Relay.
5. Connect a New wire no. 43a between the Normally Closed Relay Contact and the Receptacle going to the Clamp Open Solenoid.

VIII-4. Upgrading Radio Controls.

Several features in older Radio Controls Should be Upgraded.

First: The Radio Receivers in the older Power Units were hard wired to the Control Panel, so that the Receiver was turned on whenever the Engine Control Switch was turned to the 'on' position. The two potential problems with that arrangement were that more than one operator could try to control the Power Unit at the same time, and, in the event of a Transmitter Failure, the only way to stop a running Vibro was to turn the Power Unit off.

Second: Older Radios were wired so that it was possible to open the Clamp while the Vibro was running.

Third: If a fault or short circuit occurred, it was possible to damage the Radio circuitry.



OPERATION / MAINTENANCE MANUAL

MODEL 100 VIBRATORY HAMMER WITH MODEL 260 POWER UNIT

7032 SOUTH 196th - KENT, WA 98032 - (253) 872-0141 / FAX (253) 872-8710

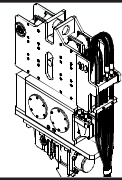

VII. MODEL 260 POWER UNIT (Continued...)

VIII-4. Upgrading Radio Controls (Continued...)

To upgrade, proceed as follows:

1. Connect and hard wire one end of a 16 Gage, 12 conductor 'SO' cord to the Radio. Wire the other end to an Amphenol Plug (#MS3106A-28-18P).

- | | |
|---------------------------------------|--|
| a. Let Pin# A be Orange wire #33. | g. Let Pin# G be Blue/Blk wire #25. |
| b. Let Pin# B be Blue wire #16. | h. Let Pin# H be Black/White wire #27. |
| c. Let Pin# C be White/Blk wire #40. | i. Let Pin# J be Green wire #43. |
| d. Let Pin# D be Red/Blk wire #26. | j. Let Pin# K be White wire #45. |
| e. Let Pin# E be Green/Blk wire #41. | k. Let Pin# L be Red wire #46.(spare) |
| f. Let Pin# F be Orange/Blk wire #42. | l. Let Pin# M be Black #28. |

2. Remove the cube relays, and wiring from the inside of the Receiver Enclosure. On the Lid of the Receiver enclosure (not the outer enclosure), install a DIN rail to hold the following:

- 6 ea.- Idec # SH1B-05 Base
- 6 ea.- Idec # RH1B-DC24V Relay
- 3 ea.- I/R # 6056 Diode
 - a. SPDT Power Relay (PR)
 - b. SPDT Emergency Stop Relay (ESR)
 - c. SPDT Clamp Open Relay (COR)
 - d. SPDT Clamp Close Relay (CCR)
 - e. SPDT Governor Raise Relay (GRR)
 - f. SPDT Governor Lower Relay (GLR)

- 2 ea.- Idec # SH3B-05 Base
- 2 ea.- Idec # RH3B-DC24V Relay
 - a. 3PDT Drive Forward Relay (DFR)
 - b. 3PDT Drive Reverse Relay (DRR)

3. Continue to use the Off Delay Timer, mounted on the bottom of the Outer Enclosure.

- 1 ea.- Syrlec # S08 Base (or =)
- 1 ea.- Syrlec # O-CR-U-110 (or =)

4. Connect 'So' cord and internal wiring per New Dwg.



OPERATION / MAINTENANCE MANUAL

MODEL 100 VIBRATORY HAMMER WITH MODEL 260 POWER UNIT

7032 SOUTH 196th - KENT, WA 98032 - (253) 872-0141 / FAX (253) 872-8710

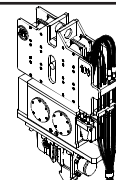

- APPENDIX A - **CUMMINS 6C ENGINE**

A-1. ENGINE OPERATION INSTRUCTIONS

The following sections are basic instructions for maintenance and operation of the **APE Model 240 Power Unit Engines**. All maintenance should be performed by qualified personnel who are familiar with the equipment. (Consult the factory for additional information.)

A-1A. PRE-START INSPECTION AND PROCEDURES

1. Make a "walk-around" inspection of the engine and components for the oil, water or fuel leaks and general appearance. Correct minor adjustments before they develop into major repair jobs.
2. Check the crankcase oil level. Maintain the oil level between the ADD and FULL marks on the dipstick. See OIL SPECIFICATIONS for type of oil to use.
3. Check oil level(s) on driven equipment.

WARNING: Check the engine coolant level when the engine is cool. If the engine is warm, steam may spray outward under high pressure and cause personal injury.

4. Check the engine jacket coolant level. Slowly turn the pressure cap until the cap is removed. Maintain coolant level to the base of the fill pipe.
5. Check the fuel supply. Keep fuel tanks full, as partially filled tanks will collect moisture. See the FUEL SPECIFICATIONS for type of fuel.

KEEP THE FUEL SUPPLY CLEAN

6. Open the raw water valve on the engine jacket heat exchanger system (if so equipped). Prime the raw water pump if the raw water system has been drained.
7. Reset shutoff devices. See the topic, ATTACHMENTS, Emergency Shutoff Devices and Alarms. If the engine is equipped with an air safety shutoff control, and was tripped to the shutoff position, reset the latch to the run position.
8. Open the fuel supply valve. If the engine has not run for some time it may be necessary to prime the system. See the topic, PRIMING THE FUEL SYSTEM.
9. Disconnect any battery charger which is not protected against starting motor drain.
10. Disengage the clutch, or open the circuit breaker on a generator set.



OPERATION / MAINTENANCE MANUAL

MODEL 100 VIBRATORY HAMMER WITH MODEL 260 POWER UNIT

7032 SOUTH 196th - KENT, WA 98032 - (253) 872-0141 / FAX (253) 872-8710

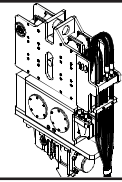

- APPENDIX A - **CUMMINS 6C ENGINE**

A-1B. STARTING THE ENGINE

CAUTION: Do not engage the starter when the flywheel is moving.

Electric Starting

1. Move the governor control lever to approximate half engine speed position.
2. Use starting aids if required.
3. Push the START button; or turn the HEAT START switch to the START position, depending upon the control the engine has. Release the control as soon as the engine starts.

For generator sets, place the AUTO-MAN switch in the MAN position to crank the engine. As soon as the engine starts, and the engine speed reaches 600 rpm and oil pressure is approximately 22 psi (1.5 kg /CM²), the starter motor will disconnect from the circuit. (The STOP position is used to stop the diesel engine.)

If the engine fails to start within 10 seconds, move the governor control lever to the fuel off position, then continue to crank for 10 seconds. This will clear the cylinders of unburned fuel.

If the engine fails to start after 30 seconds of cranking, allow the engine to cool for 2 minutes before repeating the starting procedure.

CAUTION: Prolonged cranking at low oil pressure can activate the mechanical safety shut-off. If the reset lever is in the shut-off position, reset the mechanical shut-off control.

CAUTION: NEVER use starting aids when the engine is warm and running.

Air Starting

1. Open and close the bleed valve on the bottom of the air tank to drain condensation and oil carryover.
2. Check the air supply pressure. The air start must have 100 PSI (7 kg/cm²) to operate properly.
3. Keep oil level, in the oiler jar, at least half full. Add oil if necessary.
4. Push the air valve control in to crank the engine. As soon as the engine starts, release the valve.



OPERATION / MAINTENANCE MANUAL

MODEL 100 VIBRATORY HAMMER WITH MODEL 260 POWER UNIT

7032 SOUTH 196th - KENT, WA 98032 - (253) 872-0141 / FAX (253) 872-8710

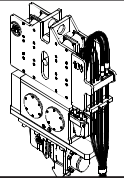

- APPENDIX A - CUMMINS 6C ENGINE

A-1. OPERATION INSTRUCTIONS (Continued...)

A-1C. ENGINE OPERATION

After the engine starts, and at frequent intervals while the engine is operating, the gauges should be observed. Determine the normal reading for each gauge. Investigate the cause whenever there is a significant change in the reading.

Tachometer

The tachometer indicates engine RPM. The high idle RPM and the full load RPM are stamped on the engine's information plate. The engine can be operated between these two speed limits for long periods of time without shortening engine life. Prolonged operation at high idle with little or no load can cause adverse engine operation.

Engine Oil Pressure

If the gauge reading fluctuates after the load is stable:

1. Remove the load.
2. Reduce engine speed to low idle.
3. Observe the oil level. Maintain the oil level between the ADD and FULL mark on the dipstick. If the reading continues to fluctuate when the oil level is correct, stop engine and call your Caterpillar dealer.

Engine Jacket Water Temperature

The engine should operate within the NORMAL (green) range. If the engine is operating in the (red) range and steam becomes apparent:

1. Reduce the load and engine RPM.
2. Inspect for coolant leaks.
3. Determine if the engine must be shut down immediately; or if the engine can be safely cooled by reducing the load. (See COOLING SPECIFICATION INSTRUCTIONS.)

CAUTION: Do not add cold water to a hot engine: Cracking of engine components may occur. Allow the engine to cool, then add coolant.



OPERATION / MAINTENANCE MANUAL

MODEL 100 VIBRATORY HAMMER WITH MODEL 260 POWER UNIT

7032 SOUTH 196th - KENT, WA 98032 - (253) 872-0141 / FAX (253) 872-8710

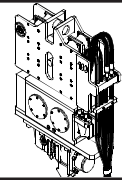

- APPENDIX A - CUMMINS 6C ENGINE

A-1C. ENGINE OPERATION (Continued...)

Water Temperature Gauge

If the temperature gauge reading registers in or near the cold range (white) while operating under load:

1. Check the water temperature gauge for accuracy.
2. Check the temperature regulators for proper temperature range. Replace regulators if necessary.

Fuel pressure

If the fuel filter gauge registers in the OUT range, clean the primary fuel filter, if so equipped. Install new secondary or final fuel filter elements if gauge still registers OUT. See the FUEL MAINTENANCE INSTRUCTIONS and FUEL SPECIFICATIONS.

Ammeter

The ammeter reading is normal when the indicator is at or on the (+) side of zero, when the engine is running at rated speed. If indicator is to the left (-) side of zero, investigate and correct cause.

Air Cleaner Service Indicator

When the gauge indicator locks in the red range, service the air cleaner. With the engine stopped.

Calibrated Gauges

Calibrated gauges are used on some engines to monitor the engine systems. If an abnormal engine condition develops, determine and analyze and correct the cause before a failure and downtime occurs.

If any of the gauges register at or outside the operating limits, investigate and correct any malfunction. See TROUBLESHOOTING for guidance.

**WARNING: Shut the engine down if work on or around the engine is required.
DO NOT OPERATE THE ENGINE WITH THE GAUGES REGISTERING AT OR OUTSIDE
THE LIMITS.**



OPERATION / MAINTENANCE MANUAL

MODEL 100 VIBRATORY HAMMER WITH MODEL 260 POWER UNIT

7032 SOUTH 196th - KENT, WA 98032 - (253) 872-0141 / FAX (253) 872-8710

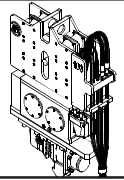

- APPENDIX A - CUMMINS 6C ENGINE

A-1C. ENGINE OPERATION (Continued...)

Altitude Operation

The fuel system settings and altitude limits are stamped on the engine information plate. When an engine is moved to a higher altitude, these settings must be changed by your Caterpillar dealer in order to prevent damaging the turbocharger, and to provide maximum engine efficiency. If the engine is moved to a lower altitude than that which is stamped on the engine information plate, the engine can be operated safely; however, it will deliver less than rated horsepower, and the fuel settings should be changed by your Caterpillar dealer to obtain rated horsepower.

Stopping

1. Flywheel clutch operation: Quickly pull the clutch lever to the released position.
2. Reduce engine speed to half speed. Run for 5-10 minutes to cool engine.
3. Reduce engine speed to low idle.
4. Observe the crankcase oil level while the engine is idling. Maintain the oil level between the ADD and FULL marks on the side of the dipstick stamped, CHECK WITH ENGINE RUNNING. See the LUBRICATION AND MAINTENANCE SECTION.
5. Stop the engine.

After Stopping Checks And Procedures

1. Fill the fuel tank. See the LUBRICATION AND MAINTENANCE SECTION: Fuel Tank Maintenance.
2. Drain the raw water system if below freezing temperatures are expected; see: Draining Raw Water System.
3. If below freezing temperatures are expected, allow the engine jacket water expansion tank to cool, then check the coolant for proper antifreeze protection. Add permanent-type antifreeze, if required.
4. Repair any leaks, make minor adjustments, tighten loose bolts, etc.
5. Observe the Service Meter reading. Perform the periodic maintenance as instructed in the LUBRICATION AND MAINTENANCE CHART.



OPERATION / MAINTENANCE MANUAL

MODEL 100 VIBRATORY HAMMER WITH MODEL 260 POWER UNIT

7032 SOUTH 196th - KENT, WA 98032 - (253) 872-0141 / FAX (253) 872-8710

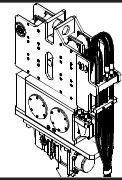

- APPENDIX A - CUMMINS 6C ENGINE

A-1C. ENGINE OPERATION (Continued...)

Starting The Engine

1. Perform all prestart checks outlined previously.
2. Place the CONTROL switch in the MANUAL position to crank the engine.
3. When the engine starts and engine rpm reaches 600 rpm and the oil pressure registers 22 psi (1.5 kg/cm²) the starting motor will automatically disconnect from the start circuit.
4. Start the load.
5. Regulate the engine speed with the RAISE LOWER switch to the required instrument panel gauge readings.

Stopping The Engine

1. Remove the load.
2. Reduce engine speed to low idle: Push down and hold the RAISE-LOWER switch until the engine low idle speed is reached.
3. While the engine is idling, check the engine oil level. Oil level must be maintained between the ADD and FULL marks on the side of the dipstick marked "CHECK WITH ENGINE RUNNING".
4. Stop the engine.

(Solenoid Shutoff)

- a. Move the control switch to the STOP or OFF positions. (Do not confuse this with the "RAISE-LOWER" switch.)

(PSG Governor)

- b. Move the shutoff lever forward, or hold the lever up, depending upon installation. Hold the lever in this position until the engine stops.

5. Fill the fuel tank. See the LUBRICATION AND MAINTENANCE section.
6. Drain the raw water system if below freezing temperatures are expected.

Observe the Service Meter reading. Perform the periodic maintenance as instructed in the LUBRICATION AND MAINTENANCE CHART.



OPERATION / MAINTENANCE MANUAL

MODEL 100 VIBRATORY HAMMER WITH MODEL 260 POWER UNIT

7032 SOUTH 196th - KENT, WA 98032 - (253) 872-0141 / FAX (253) 872-8710

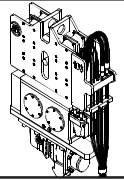

- APPENDIX A - CUMMINS 6C ENGINE

A-1D. Determining Cause Of Shutdown

CAUTION: If the engine has been shutdown by a safety device, don't start the engine and place it into service without having the cause of the shutdown investigated and corrected

Low Oil Pressure Checks

If the low oil pressure shutoff control has stopped the engine, make the following checks:

1. Check the water temperature gauge. Determine if the engine was overheated. Check for external water leaks.

WARNING: Beware of steam or scalding water. Do not attempt to loosen the radiator cap until the temperature gauge indicates the coolant has sufficiently cooled. Then, loosen the cap slowly.

2. Check the oil level. Oil level must be between the ADD and FULL marks on the side of the dipstick stamped CHECK WITH ENGINE STOPPED.
3. If the oil level is below the ADD mark, check for oil spray and/or oil accumulations. If any are found, have the necessary repairs made. Before starting, add oil to the FULL mark.
4. Reset the shutoff control.
5. Remove the load and start the engine at its slowest speed. Be prepared to shut the engine down manually.
6. Be alert for unusual sounds or noises. If the engine knocks, stop the engine immediately and call your engine dealer.
7. If the engine blows excessive black exhaust or has excessive crankcase blow-by, the engine may need reconditioning. Stop the engine and call your engine dealer.
8. If the engine runs satisfactorily, observe the oil pressure gauge. If satisfactory pressure is not indicated, shut the engine down; call your engine dealer.
9. If proper oil pressure is registered, check to see if the reset knob has moved to the run position. If the knob does not move, stop the engine. Check the shutoff control, the oil line, and the oil pressure gauge. Have necessary repairs made.
10. If the oil pressure gauge registers normal oil pressure, if the knob on the shutoff control moves to the run position, and if the engine operation is otherwise satisfactory, determine if the high water temperature shutoff may have shut down the engine.



OPERATION / MAINTENANCE MANUAL

MODEL 100 VIBRATORY HAMMER WITH MODEL 260 POWER UNIT

7032 SOUTH 196th - KENT, WA 98032 - (253) 872-0141 / FAX (253) 872-8710

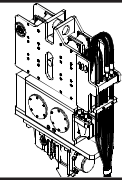

- APPENDIX A - CUMMINS 6C ENGINE

A-1D. Determining Cause Of Shutdown (Continued...)

High Water Temperature Checks - Engine Running

1. Determine if the load was too great for the engine - Reduce the load and allow the engine to cool while running.
2. If pressure steam or water leaks are visible, remove the load and stop the engine. Have necessary repairs made.
3. Check for collapsing or deteriorated water hoses. Have repairs made.
4. Check for noisy water pump operation. Have necessary repairs made.
5. Refill the cooling system with a solution of water and permanent-type antifreeze if below freezing temperatures are expected; or with a solution of approved water and Corrosion Inhibitor. Follow the instructions on the container.

WARNING: DO NOT remove the pressure cap on an overheated engine. The coolant is under pressure and relieving the pressure will cause the coolant to flash into steam.

NOTE: If there is adequate coolant in the cooling system, gradual cooling is preferred by running the engine at half speed. This eliminates hot spots in the engine, and possible failure.

High Water Temperature Checks-Engine Stopped and Cold

1. Check coolant level. Determine if the coolant has proper antifreeze protection. A 50-50 solution of permanent-type antifreeze and approved water will give protection below -200F (-290C).
2. Check to be sure the raw water valve has been opened.
3. Check engine room vents and/or louvers. Be sure the engine is receiving sufficient air.
4. Be sure temperature regulators are operating at proper temperature range.
5. Inspect all water hoses carefully for collapsing, external and internal failures. Replace hoses as required.
6. Have the cooling system cleaned.

CAUTION: If severe or prolonged overheating has occurred, contact your engine dealer to have your engine checked for possible damage.



OPERATION / MAINTENANCE MANUAL

MODEL 100 VIBRATORY HAMMER WITH MODEL 260 POWER UNIT

7032 SOUTH 196th - KENT, WA 98032 - (253) 872-0141 / FAX (253) 872-8710

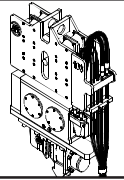

- APPENDIX A - CUMMINS 6C ENGINE

A-2. MAINTENANCE RECOMMENDATIONS

CAUTION: Never add coolant to an overheated engine; allow the engine to cool first.

Cooling

Check specific gravity of antifreeze solution frequently in cold weather to assure adequate protection.

Coolant should be drained and replaced "Every 2000 Service Meter Units." With additions of Cooling System Inhibitor or the use of Coolant Conditioner Elements as recommended, the drain period can be extended to "Every 4000 Service Meter Units."

All water is corrosive at engine operating temperature. The cooling system should be protected with inhibitor at all times regardless of concentration of antifreeze. This can be done by maintaining a 3% concentration of liquid Cooling System Inhibitor or by using Coolant Conditioner Elements.

Never use both the liquid cooling system inhibitor and coolant elements at the same time.

Do not use Cooling System Inhibitor or Coolant Conditioner Elements with Dowtherm 209 Full-Fill Coolant.

Whenever draining and refilling cooling system, always recheck the coolant level when the engine reaches normal operating temperature.

Filling at over 5 U.S. gallons (19 liters) per minute can cause air pockets in the cooling system.

Premix antifreeze solution to provide protection to the lowest expected ambient temperature. Pure undiluted antifreeze will freeze at -100F (-23,C).

Operate with a thermostat in the cooling system all year-round. Cooling system problems can arise without a thermostat.

Electrical

CAUTION: When using jumper cables to start the engine, be sure to connect in parallel: POSITIVE (+) to POSITIVE (+) and NEGATIVE (-) to NEGATIVE (-).

Scheduled Oil Sampling

Use scheduled Oil sampling to monitor the engine's condition and maintenance requirements. Each oil sample should be taken when the oil is hot, and well mixed, to insure a sample which is representative of the oil in the compartment.

Consult your engine dealer for complete information, and assistance in establishing a Scheduled Oil Sampling program for your equipment.



OPERATION / MAINTENANCE MANUAL

MODEL 100 VIBRATORY HAMMER WITH MODEL 260 POWER UNIT

7032 SOUTH 196th - KENT, WA 98032 - (253) 872-0141 / FAX (253) 872-8710

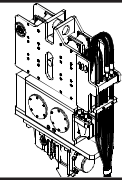

- APPENDIX A - **CUMMINS 6C ENGINE**

A-2. MAINTENANCE RECOMMENDATIONS (Continued...)

Fuel

CAUTION: Fill fuel tank at the end of each day of operation to drive out moisture-laden air and to prevent condensation. Do not fill the tank to the brim. The fuel expands when it gets warm and may overflow.

Water and sediment should be drained from the fuel tank at the start of each shift or after the fuel tank has been filled and allowed to stand for 5 to 10 minutes.

Drain fuel tank of moisture and sediment as required by prevailing conditions.

After changing fuel filters, always bleed fuel system to remove air bubbles from system.

Air intake

Service air cleaners when RED band in indicator locks in visible position.

A-2A. LUBRICATION SPECIFICATIONS

Crankcase Lubricating Oils

Use oils which meet Engine Service Classification (MIL-L-2104D) or CD/TO-2. These are additive-type oils that have been approved for use in Diesel Engines.

Consult the "EMA Lubricating Oils Data Book", Form SEBU5939, for a listing of CD oil brands.

The proper SAE grade of oil to select is determined by the ambient temperature at which the engine is started and the maximum ambient temperature in which the engine will be operating. To determine if the oil in the crankcase will flow in cold weather, remove the oil dipstick before starting. If the oil will flow off, the oil is fluid enough to circulate properly.

Lubricating Grease

Use Multipurpose-type Grease (MPGM) which contains 3-5% molybdenum disulfide conforming to MIL-M-7866, and a suitable corrosion inhibitor. NLGI No.2 Grade is suitable for most temperatures. Use NLGI No. 0 or No. 1 Grade for extremely low temperatures.



OPERATION / MAINTENANCE MANUAL

MODEL 100 VIBRATORY HAMMER WITH MODEL 260 POWER UNIT

7032 SOUTH 196th - KENT, WA 98032 - (253) 872-0141 / FAX (253) 872-8710

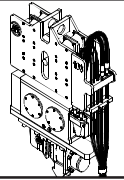

- APPENDIX A - **CUMMINS 6C ENGINE**

A-2. MAINTENANCE RECOMMENDATIONS (Continued...)

A-2B. FUEL SPECIFICATIONS

No. 2 fuel oil and No. 2D diesel fuel are recommended for use in Diesel Engines. In extreme cold temperatures use No. 1 fuel oil or No.1 D diesel fuel.

In selecting a fuel, note that distillate fuels are especially desirable because the fuel is heated to a vaporous state and condensed, thus eliminating all sediment and residue.

A-2C. COOLANT SPECIFICATIONS

Water used in the jacket water cooling system should be clean, and as free as possible from scale forming minerals or corrosive chemicals. Artificially softened water should not be used. Treating the water with Coolant Inhibitor, or equivalent will help prevent the formation of rust and pitting. It will also retard, and in some cases completely eliminate, mineral deposits in the engine.

The most efficient and satisfactory corrosion protection for the cooling system is to maintain proper level of coolant inhibitor and antifreeze solution. The use of auxiliary water filters is not recommended.

During freezing weather use the proper permanent type antifreeze and water solution to prevent freezing.

Before placing the engine in operation, make sure a 3% concentration of Corrosion Inhibitor has been added to the cooling system. This 3% concentration must be maintained in cooling systems which are filled with water and systems protected with ethylene glycol antifreeze mixture, regardless of antifreeze concentration.

WARNING: Inhibitors contain alkali. Avoid contact with eyes. To prevent personal injury, avoid prolonged or repeated contact with skin.



OPERATION / MAINTENANCE MANUAL

MODEL 100 VIBRATORY HAMMER WITH MODEL 260 POWER UNIT

7032 SOUTH 196th - KENT, WA 98032 - (253) 872-0141 / FAX (253) 872-8710

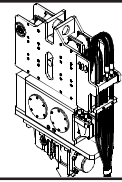

- APPENDIX A - CUMMINS 6C ENGINE

A-2. MAINTENANCE RECOMMENDATIONS (Continued...)

A-2D. LUBRICATION AND MAINTENANCE

The LUBRICATION AND MAINTENANCE CHART lists all serviceable items commonly ordered on this engine. The maintenance tune intervals are expressed in "Operating Hours".

Daily	Weekly	250 Hours or 6 months	1500 Hours or 1 Year	6000 Hours or 2 Years	6000 Hours or 3 Years
<ul style="list-style-type: none"> • Check operator's report • Check and bring to correct level <ul style="list-style-type: none"> - Engine Oil - Coolant • Visually inspect fan. • Visually inspect engine for damage, leaks, loose or frayed belts and correct or record for future action. • Drain fuel-water separator. 	<p>Repeat Daily Check</p> <ul style="list-style-type: none"> • Check air intake system for wear points or damage to piping, loose clamps, and leaks. • Check air cleaner restriction. • Check and clean air cleaner element. • Drain moisture from air tanks. 	<p>Repeat Daily and Weekly Check</p> <ul style="list-style-type: none"> • Change Lubricating Oil. • Change Lubricating Oil Filters. • Change Fuel Filter. • Change Coolant Filter. • Clean Crankcase Breather. • Check engine coolant concentration level. Add make-up if required. • Replace final Fuel Filter/Clean primary Fuel Filter. Drain water from fuel tank. • Inspect/Replace Alternator, Fan and Accessory Drive • Belts. Inspect/Replace • Hoses and Clamps. Lubricate Fan Drive • Bearings. Clean/Check Battery electrolyte level. 	<p>Repeat Previous Intervals</p> <ul style="list-style-type: none"> • Adjust valves and injectors. • Steam clean engine. • Check torque on turbocharger mounting nuts. • Check torque on engine mounting bolts. • Replace hoses as required. • Check/Adjust engine valve lash. • Check/Adjust low idle speed. • Test/Exchange fuel injection nozzles. • Inspect coolant pump. Clean cooling system. (Internal) • Inspect/Rebuild Alternator. 	<p>Repeat Previous Intervals</p> <ul style="list-style-type: none"> • Clean cooling system and change coolant and antifreeze. • Inspect temperature regulator. • Inspect/Rebuild turbocharger. • Inspect/Rebuild starter. • Check and adjust clutch. 	<p>Repeat Previous Intervals Which Are Due</p> <ul style="list-style-type: none"> • Clean and calibrate the following: (Rebuild or exchange if required.) <ul style="list-style-type: none"> - Injectors. - Fuel pump. - Air compressor. - Fan clutch. - Water pump. - Fan hub. - Fan idler pulley assembly. - Vibration damper.

Follow the manufacturer's recommended maintenance procedures for the starter, alternator, generator, batteries, electrical components, engine brake, exhaust brake, air compressor, freon compressor, and fan clutch.
At each scheduled maintenance interval, perform all previous maintenance checks which are due for scheduled maintenance.



OPERATION / MAINTENANCE MANUAL

MODEL 100 VIBRATORY HAMMER WITH MODEL 260 POWER UNIT

7032 SOUTH 196th - KENT, WA 98032 - (253) 872-0141 / FAX (253) 872-8710

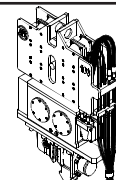

- APPENDIX A - CUMMINS 6C ENGINE

A-2E. ELECTRICAL SYSTEM

The following topics describe care and maintenance of the electrical system components. These components functioning together produce the energy needed for operating the electrical equipment on the engine and each is dependent upon the others for satisfactory operation. In the event of failure or improper operation, it is essential to check the entire electrical system as a defect in one component can cause damage to another. Many electrical system problems can be traced to loose or corroded connections. Keep connections tight and make sure the wiring insulation is in satisfactory condition. Most of the electrical system testing can be performed while the components are on the engine. It should be remembered, if a malfunction is found on test, the component must be removed for further testing, repair or replacement.

Battery

Every 250 hours check the electrolyte level of each cell and the general condition of the battery. Maintain the electrolyte level to the base of each vent well. The make-up water must be one of the following (in order of preference):

1. Distilled water.
2. Odorless, tasteless drinking water-
3. Iron free water.

WARNING: Never add acid or electrolyte.

Cleaning Battery

Mix a weak solution of baking soda and water. Apply the solution with a soft bristle brush. Be careful not to get cleaning solution into the battery. Thoroughly rinse the battery and battery tray with clean water. Apply grease to battery cable clamps and terminals and to all threads.

-Installing Battery

1. Be sure the battery tray is clean and free of foreign objects.
2. Be sure terminal posts and cable clamps are clean.
3. Place the battery in the tray. Tighten the hold down clamps evenly until the battery is snug. Do not over tighten.
4. Connect the "hot" terminal first. Be sure the top of the cable terminal is pushed down even with the top of the terminal post. Tighten the clamp firmly.

WARNING: Always connect the "hot" terminal first to minimize arcing. Otherwise injury or damage could result.

5. Connect the "grounded" terminal last. Be sure the top of the cable terminal is pushed down even with the top of the terminal post. Tighten the clamp firmly.



OPERATION / MAINTENANCE MANUAL

MODEL 100 VIBRATORY HAMMER WITH MODEL 260 POWER UNIT

7032 SOUTH 196th - KENT, WA 98032 - (253) 872-0141 / FAX (253) 872-8710

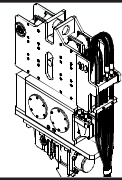

- APPENDIX A - CUMMINS 6C ENGINE

A-2E. ELECTRICAL SYSTEM (Continued...)

Charging the Battery

WARNING: Never smoke in the area where batteries are being charged. Hydrogen gas is given off at each vent cap during charging. Hydrogen mixed with air is highly explosive.

1. Connect positive charger clamp to positive battery terminal.
2. Connect negative charger clamp to negative battery terminal.
3. Connect charger power cord to proper outlet.
4. Allow battery to charge slowly.

CAUTION: If battery is charged too rapidly, the battery will be damaged.

5. After the battery is charged, disconnect charger power cord from outlet; remove charger clamp from negative battery terminal; remove charger clamp from positive battery terminal.

A-3. Engine Troubleshooting.

-TROUBLESHOOTING INDEX-

ITEM	PROBLEM	ITEM	PROBLEM
1.	Engine Fails to Start	15.	Valve Lash Close-up
2.	Misfiring	16.	Premature Engine Wear
3.	Erratic Engine Speed	17.	Coolant in Engine Lubricating Oil
4.	Low Power	18.	Excessive Black or Gray Smoke
5.	Excessive Vibration	19.	Excessive White or Blue Smoke
6.	Heavy Combustion Knock	20.	Low Engine Oil Pressure
7.	Valve Train Clicking Knock	21.	High Lubricating Oil Consumption
8.	Oil in Coolant	22.	Abnormal Engine Coolant Temperature
9.	Mechanical Knock	23.	Starting Motor Fails to Crank
10.	Excessive Fuel Consumption	24.	Alternator Fails to Charge
11.	Loud Valve Train Noise	25.	Alternator Charging Rate Low or Unsteady
12.	Excessive Valve Lash	26.	Alternator Charging Rate High
13.	Valve Spring Retainer Free	27.	Alternator Noisy
14.	Slobber	28.	Stalls at Low Speed



OPERATION / MAINTENANCE MANUAL

MODEL 100 VIBRATORY HAMMER WITH MODEL 260 POWER UNIT

7032 SOUTH 196th - KENT, WA 98032 - (253) 872-0141 / FAX (253) 872-8710

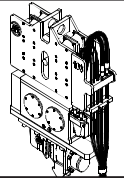

- APPENDIX A - CUMMINS 6C ENGINE

A-3. Engine Troubleshooting (Continued...)

Possible Causes	Remedy
1. ENGINE FAILS TO START	
No Fuel to Engine	Check for empty fuel tank, plugged fuel tank connections, obstructed or kinked fuel suction lines, fuel transfer pump failure, or plugged fuel filters.
Shutoff Solenoid Sticking*	Solenoid must be energized to shut off engine. Actuate the control that operates the shutoff solenoid and listen for a clicking sound. If clicking sound is not evident and engine will not start, remove the solenoid. Again try to start the engine. If the engine starts, the solenoid is bad. Replace the solenoid.
Fuel Transfer Pump	At cranking speed, the fuel transfer pump should supply fuel to the engine at 3 PSI (20 kPa). If fuel pressure is less than 3 PSI (20 kPa), replace the fuel filter. Check for air in fuel system, sticking, binding or defective fuel bypass valve. If pressure is still low, replace the fuel transfer pump.
Engine Improperly Timed	See your authorized dealer.
Glow Plug Failure	Check glow plugs.
Automatic and Safety Shutoff Controls	Check shutoff controls to ensure they are set properly. See Starting Procedures.
*Optional Equipment	
2. MISFIRING	
Defective Fuel Injection Nozzle or Fuel Pump	Run the engine at the speed where the defect is most pronounced. Momentarily loosen the fuel line nut on the injection pump to "cut out" that cylinder. Check each cylinder in this manner. If one is found where loosening makes no difference in irregular operation, the pump and nozzle for only that cylinder need be treated.
Improper Valve Lash	Set to specified clearance.
Incorrect Fuel Injection Timing	See your authorized dealer.
Low Fuel Supply Pressure	Check fuel supply line for leaks or kinks, air in fuel system, sticking, binding, or defective fuel bypass valve. Replace fuel filter. Check fuel pressure. Fuel transfer pump should supply fuel at 20 to 30 PSI (1.4to2.1kg/CM ²) to the engine when the engine is fully loaded.
Broken or Leaking High Pressure Fuel Line	Replace the line.
Air in Fuel System	Find source of air entry and correct. Bleed system.
Bent or Broken Push Rod	Replace push rod.



OPERATION / MAINTENANCE MANUAL

MODEL 100 VIBRATORY HAMMER WITH MODEL 260 POWER UNIT

7032 SOUTH 196th - KENT, WA 98032 - (253) 872-0141 / FAX (253) 872-8710

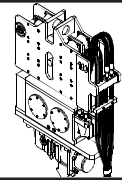

- APPENDIX A - CUMMINS 6C ENGINE

A-3. Engine Troubleshooting (Continued...)

Possible Causes	Remedy
3. ERRATIC ENGINE SPEED	
Governor Control Linkage	Adjust external linkage to obtain sufficient travel. Replace if damaged, bent, or linkage is too short.
Governor Failure	Look for damaged or broken springs, linkage, or other components. Determine if the rack can be moved manually. If any distress is noted in any of these components, replace as necessary.*
4. LOW POWER	
Fuel Nozzle Failure	Run the engine at the speed where the defect is most pronounced. Momentarily loosen the fuel line nut on the injection pump to "cut out" that cylinder. Check each cylinder in this manner. If one is found where loosening makes no difference in irregular operation, the pump and nozzle for only that cylinder need be tested.
Poor Quality Fuel	Drain, clean and bleed fuel system. Replace fuel filter. Fill fuel tank with proper grade of fuel.
Turbocharger Carboned or Otherwise Dragging	Inspect and repair or replace turbo charger as necessary.*
Leaks in Air Induction System	Check inlet manifold pressure. Check air cleaner for restriction.
Incorrect Fuel Injection Timing	See your authorized dealer.
Excessive Valve Lash	Set to specified clearance.
Low Fuel Supply Pressure	Check fuel supply line for leaks or kinks, air in fuel system, sticking, binding or defective fuel bypass valve. Replace fuel filter. Check fuel pressure. Fuel transfer pump should supply fuel to 20 to 30 PSI(1.4 to 2.1kg/CM2) to the engine when the engine is fully loaded.
5. EXCESSIVE VIBRATION	
Loose, Worn or Defective Engine Mounts as necessary.	Tighten all mounting bolts securely. Replace components
Loose Pulley and Damper	Retighten
Loose or Worn Coupling on Driven Equipment	Inspect, align and tighten coupling to driven equipment.
Defective Damper or Pulley	Replace damper or pulley.
Misfiring	See ITEM 2.



OPERATION / MAINTENANCE MANUAL

MODEL 100 VIBRATORY HAMMER WITH MODEL 260 POWER UNIT

7032 SOUTH 196th - KENT, WA 98032 - (253) 872-0141 / FAX (253) 872-8710

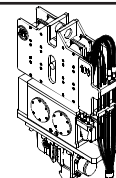

- APPENDIX A - CUMMINS 6C ENGINE

A-3. Engine Troubleshooting (Continued...)

Possible Causes	Remedy
6. HEAVY COMBUSTION KNOCK	
Air in Fuel System	Bleed air from system.
Defective Fuel Injection Pump Plunger and Barrel Assembly	Replace.*
Defective Fuel Injection Nozzle	Replace.
Incorrect Fuel Injection Timing	See your authorized dealer.*
7. VALVE TRAIN CLICKING NOISE	
Excessive Valve Lash	Set to specified clearance.
Broken Valve Spring(s)	Replace valve spring(s) and all other damaged components.*
Insufficient Lubrication	Check lubrication in valve compartment. Should be very wet at all speeds. Oil passages should be cleaned, especially those leading to the cylinder head.
8. OIL IN COOLANT	
Failed Oil Cooler Core	Replace oil cooler core.
Failed Head or Spacer Plate Gaskets	Replace head and spacer plate gaskets.
Cracked or Defective Cylinder Block	Replace cylinder block.*
Cracked or Defective Head	Replace cylinder head.
9. MECHANICAL KNOCK	
Engine Connecting Rod Bearing Failure	Replace the bearing. Check the connecting rod and crankshaft. Replace if necessary.*
Main Bearing Failure	Replace bearings.*
Damaged Timing Gear Train	Replace components as necessary.*
Broken Crankshaft	Replace crankshaft.*
Fuel Dilution of Crankcase Oil	Correct fuel leakage into crankcase oil.

*Authorized dealers are equipped with the necessary tools and personnel familiar with disassembly procedures to perform these services.



OPERATION / MAINTENANCE MANUAL

MODEL 100 VIBRATORY HAMMER WITH MODEL 260 POWER UNIT

7032 SOUTH 196th - KENT, WA 98032 - (253) 872-0141 / FAX (253) 872-8710

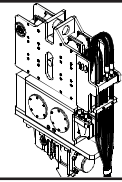

- APPENDIX A - **CUMMINS 6C ENGINE**

A-3. Engine Troubleshooting (Continued...)

Possible Causes

Remedy

10. EXCESSIVE FUEL CONSUMPTION

Fuel System Leaks	Large changes in fuel consumption may result. Internal leaks will probably be accompanied by low engine oil pressure and increased oil level in the engine oil sump. Replace leaking components.
Fuel and Combustion Knock	Small but measurable increases in fuel consumption maybe the result of defective fuel nozzles, misfiring or factors contributing to loss of power. See ITEM 2 and ITEM 5.
Incorrect Fuel Injection Timing	See your authorized dealer.

11. LOUD VALVE TRAIN NOISE

Bent or Broken Valves	Replace damaged parts.*
Broken Camshaft	Replace all damaged parts. Clean engine thoroughly.
Broken or Severely Worn Valve Lifters	Replace camshaft and valve lifters. Check for sticking valves and bent valve stems. Clean engine thoroughly. Set valve lash to specified clearance.

12. EXCESSIVE VALVE LASH

Severely Worn Cam Lobes	Check valve lash. Replace camshaft and followers. Clean engine thoroughly. Set valve lash to specified clearance.
Broken or Severely Worn Valve Lifters	Replace valve lifters. Check camshaft for wear. Check for sticking valves and bent valve stems. Clean engine thoroughly. Set valve lash to specified clearance.
Valve Tip Wear	Set valve lash to specified clearance. If wear is excessive, replace valve.
Moderate Valve Lifter Face Wear	Set valve lash to specified clearance. If wear is excessive, replace valve lifter.
Push Rod Wear	Set valve lash to specified clearance. If wear is excessive, replace push rod.
Rocker Arm Anvil Wear	Set valve lash to specified clearance. If wear is excessive, replace rocker arm.
Insufficient Lubrication	Check lubrication in valve should be very wet at high idle speeds, but only damp at low idle. Oil passages should be cleaned, especially those leading to the cylinder head.



OPERATION / MAINTENANCE MANUAL

MODEL 100 VIBRATORY HAMMER WITH MODEL 260 POWER UNIT

7032 SOUTH 196th - KENT, WA 98032 - (253) 872-0141 / FAX (253) 872-8710

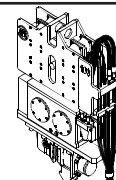

- APPENDIX A - CUMMINS 6C ENGINE

A-3. Engine Troubleshooting (Continued...)

Possible Causes	Remedy
13. VALVE SPRING RETAINER FREE	
Broken Keepers	Extensive engine damage may result from dropped valve. Replace all damaged parts.*
Broken Valve Spring	Replace valve spring.*
Broken Valve	Replace valve and any other damaged parts.*
14. SLOBBER	
Excessive Valve Guide Wear	Recondition cylinder head assembly.*
Excessive Lubricating Oil in Valve Compartment.	Check rocker arm shaft and plugs to assure that they are in place.
Worn Piston Rings and/or Liners	Inspect and replace components as necessary.*
15. VALVE LASH CLOSE-UP	
Valve Face and/or Seat Wear	Adjust valves to specified clearance. Recondition cylinder head.
16. PREMATURE ENGINE WEAR	
Intake Piping Failure (Air Cleaner)	Inspect all gaskets and piping for leaks. Repair all leaks.
Excessive Fuel Dilution of Lubricating Oil	Replace leaking components. This will probably be accompanied by high fuel consumption and low engine oil pressure. Tighten fuel injection line fittings under valve cover.
Dirt in Lubricating Oil	Locate and correct source of dirt entry. Change lubricating oil. Change oil filter.
17. COOLANT IN ENGINE LUBRICATING OIL	
Oil Cooler Failure	Replace oil cooler core.
Cylinder Head Gasket Failure	Replace gasket. Maintain proper torque on cylinder head bolts.
Cracked or Defective Cylinder Head	Replace cylinder head.*
Cracked or Defective Cylinder Block	Replace cylinder block.*

*Authorized dealers are equipped with the necessary tools and personnel familiar with disassembly and assembly procedures to perform these serviced.



OPERATION / MAINTENANCE MANUAL

MODEL 100 VIBRATORY HAMMER WITH MODEL 260 POWER UNIT

7032 SOUTH 196th - KENT, WA 98032 - (253) 872-0141 / FAX (253) 872-8710

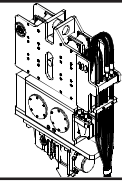

- APPENDIX A - CUMMINS 6C ENGINE

A-3. Engine Troubleshooting (Continued...)

Possible Causes

Remedy

17. COOLANT IN ENGINE LUBRICATING OIL (Cont'd)

Cylinder Liner Seal Leaking	Replace seals.*
Cracked or Defective Cylinder Liners	Replace cylinder liners.*

18. EXCESSIVE BLACK OR GRAY SMOKE

Insufficient Combustion Air	Check air cleaner for restriction. Check inlet manifold pressure. Inspect turbocharger for proper operation.
Fuel Nozzle Plugged or Leaking	Replace nozzle.
Incorrect Fuel Injection Timing	See your authorized dealer.
Fuel Ratio Control Improperly Adjusted	Adjust fuel ratio control.*

19. EXCESSIVE WHITE OR BLUE SMOKE

Valve Guides Worn	Recondition cylinder head assembly.*
Piston Rings Worn, Stuck or Broken	Replace.*
High Crankcase Oil Level	Avoid overfilling. Determine cause and drain excess oil.
Misfiring	See ITEM 2.
Fuel Injection Pump Timing Wrong	See your authorized dealer.
Air in Fuel System	Bleed fuel system.

20. LOW ENGINE OIL PRESSURE

Engine Oil Diluted with Fuel Oil	Check lip-type seal on fuel transfer pump drive shaft. Drain crankcase and refill with clean lubricant.
Excessive Crankshaft Bearing Clearance	Replace bearings and/or crankshaft.* Check oil filter operation.
Excessive Timing Gear Bearing Clearances	Inspect bearings and replace components as necessary.
Excessive Rocker Arm Bore or Rocker Arm Shaft Wear	Check lubrication. Replace components as necessary.
Defective Oil Pump	Repair or replace.*
Defective Suction Bell	Replace.



OPERATION / MAINTENANCE MANUAL

MODEL 100 VIBRATORY HAMMER WITH MODEL 260 POWER UNIT

7032 SOUTH 196th - KENT, WA 98032 - (253) 872-0141 / FAX (253) 872-8710

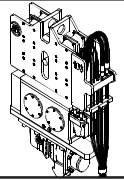

- APPENDIX A - CUMMINS 6C ENGINE

A-3. Engine Troubleshooting (Continued...)

Possible Causes	Remedy
22. LOW ENGINE OIL PRESSURE (Cont'd)	
Clogged Oil Filter or Cooler	Repair or replace as necessary.
Oil Pump Relief Valve Stuck	Clean valve and housing. Replace if necessary.
23. HIGH LUBRICATING OIL CONSUMPTION	
Oil Leaks	Replace gaskets or seals and tighten all connections.
Excessive Oil to Intake	See ITEM 15. Valve Guides.
Excessive Valve Guide Wear	See ITEM 15.
Crankcase Oil Level Too High	Avoid overfilling. Determine cause and drain excess oil.
High Oil Temperature	Check oil cooler bypass valve. Replace if defective. Clean oil cooler core.
Worn Piston Rings and/or Liner	Replace components as necessary.*
24. ABNORMAL ENGINE COOLANT TEMPERATURE	
Combustion Gases in Coolant	Determine point at which gases enter the system. Repair or replace components as necessary.
Defective Water Temperature Regulator or Temperature Gauge	Check temperature regulator for proper opening temperature and correct installation. Check temperature gauge. Replace if necessary.
Coolant Level Low	Determine cause-replace leaking gaskets and hoses. Tighten connections. Add coolant.
Air Flow Through Radiator Restricted	Remove all debris from outer surface of radiator.
Defective Water Pump	Check water pump impeller. Repair water pump as necessary.
Radiator Small for Engine Application	Install correct size radiator.
Fan Improperly Positioned in Shroud or Not Shrouded	Position fan correctly.*

*Authorized dealers are equipped with the necessary tools and personnel familiar with disassembly and assembly procedures to perform these serviced.



OPERATION / MAINTENANCE MANUAL

MODEL 100 VIBRATORY HAMMER WITH MODEL 260 POWER UNIT

7032 SOUTH 196th - KENT, WA 98032 - (253) 872-0141 / FAX (253) 872-8710

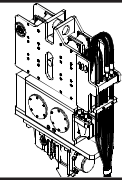

- APPENDIX A - CUMMINS 6C ENGINE

A-3. Engine Troubleshooting (Continued...)

Possible Causes

Remedy

22. ABNORMAL ENGINE COOLANT TEMPERATURE

Incorrect Fuel Injection Timing

See your authorized dealer.

Incorrect Water Piping Connections
from Engine to Radiator

Check shunt line (if equipped) and
vent line for correct installation.

23. STARTING MOTOR FAILS TO CRANK

Low Output from Battery

Check battery and charge or replace.

Defective Wiring or Switch

Repair or replace.

Defective Solenoid

Replace.

Defective Starting Motor

Repair.

24. ALTERNATOR FAILS TO CHARGE

Drive Belt Loose

Adjust belt.

Open or High Resistance in
Charging or Ground Return
Circuits or Battery Connections

Inspect all cables and connectors.
Clean, retighten or replace defective
parts.

Excessively Worn, Open or
Defective Brushes

Replace brush assembly.*

Open Rotor Field Coil

Replace rotor assembly.*

25. ALTERNATOR CHARGING RATE LOW OR UNSTEADY

Drive Belt Loose

Adjust belt.

Intermittent or High Resistance in
Charging or Ground Return Circuits
or Battery Connections

Inspect all cables and connectors.
Clean, re tighten or replace defective
parts.

Excessively Worn, Sticky, or
Defective Brushes

Replace brush assembly.*

Faulty Regulator

Replace regulator.*

Shorted or Open Rectifier Diodes

Replace defective rectifier diode
assembly in alternator.*

Grounded or Shorted Rotor

Replace rotor assembly.*



OPERATION / MAINTENANCE MANUAL

MODEL 100 VIBRATORY HAMMER WITH MODEL 260 POWER UNIT

7032 SOUTH 196th - KENT, WA 98032 - (253) 872-0141 / FAX (253) 872-8710

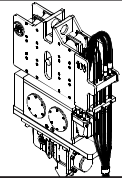

- APPENDIX A - CUMMINS 6C ENGINE

A-3. Engine Troubleshooting (Continued...)

Possible Causes	Remedy
26. ALTERNATOR CHARGING RATE HIGH	
Loose Connections	Tighten connections to alternator and regulator.
Defective Regulator	Replace regulator.
27. ALTERNATOR NOISY	
Defective Drive Belt	Replace belt.
Misaligned Belt or Pulley	Align drive pulley, alternator pulley and belt.
Loose Pulley	Tighten pulley nut. If keyway is worn, install a new pulley.
Worn Bearings	Replace bearings.
Shorted Rectifiers in Alternator	Replace diode assembly.*
Armature or Rotor Shaft Bent	Replace component.*
*Authorized dealers are equipped with the necessary tools and personnel familiar with disassembly and assembly procedures to perform these serviced.	
28. STALLS AT LOW SPEED	
Idle Speed Too Low	See your authorized dealer.
Low Fuel Supply Pressure	Check fuel supply line for leaks or kinks, air in fuel system, sticking, binding, or defective fuel bypass valve. Replace fuel filter. Check fuel pressure. Fuel transfer pump should supply fuel at 20 to 30 PSI to the engine when the engine is fully loaded.
Defective Fuel Nozzle	Replace nozzle.
Defective or Damaged Fuel Injection Pumps	Replace damaged or defective parts.
High Parasitic Loads	Check for excessive loading due to auxiliary attachments.